

Cygnus 4

Multiple Echo Ultrasonic Thickness Gauge

Operating Manual



Covers Gauge Model : M5-C4

Doc No. M5-CYG4-M-01_Iss12.doc
27 August 2021

Contents

- 1. Introduction..... 5**
 - Cygnus 4 Thickness Gauge.....5
 - Cygnus Instruments.....6
 - Gauge Kit Contents7
- 2. Gauge Preparation 8**
 - Fitting the Batteries8
 - Connecting the Probe9
 - Fitting the Neck Strap9
- 3. Selecting the Right Probe..... 11**
 - Measuring Metals..... 11
 - Measurement Modes Explained and Compared 12
 - Multiple Echo Mode (Mode 3) 12
 - Measuring Non-Steels 12
 - Measuring Non-Metals 12
 - Single Element Probes and Protective Membranes..... 13
 - Summary of Cygnus Probes 16
 - Single Element probes 16
 - The 'Probe Type' Code 17
- 4. Gauge Operation 18**
 - Gauge Controls 18
 - Turning the Gauge On 19
 - Turning the Gauge Off..... 19
 - Automatic Power Off..... 19
 - Status Information..... 20
 - Taking Thickness Measurements 20
 - Taking the Thickness Measurement..... 21
 - Echo Indicators in Multiple Echo Mode 21
 - Display Hold Function 22
 - Battery Life..... 23
 - Battery Level..... 23
 - Low Battery Indication..... 24
- 5. Calibration 25**
 - Why should I Calibrate my Thickness Gauge?..... 25
 - Calibration Options 26
 - Calibrating to a known thickness (Single or 1 Point)..... 26
 - Setting the Velocity of Sound 28
- 6. Gauge Setup 30**

Menu Operation.....	30
Settings are Saved with the Probe Type	31
Changing Numeric Values using the Navigation Keys	32
Selecting the Probe Type	33
Automatic Probe Detection	34
Measurement Units	35
Resolution Setting	35
Limit Functions.....	36
Deep Coat Function.....	39
7. Setup Menu	42
Vibrate Feature	42
Brightness Setting	42
Power Off Setting	43
Set Time and Set Date	43
8. General Points On Thickness Gauging	45
9. Troubleshooting	46
The Gauge will not Switch On	46
Difficulty obtaining a Reading	46
If Readings are Erratic or Unstable	46
Tips for Optimising Battery Life.....	46
10. Updating your Gauge	48
Update Software.....	48
Gauge Firmware Files.....	48
11. Care and Servicing	49
Cleaning the Gauge.....	49
Batteries	49
Environmental.....	49
Repairs	49
Returning the Gauge for Servicing.....	50
12. Information	51
Technical Specifications	51
Table of Sound Velocities	54
Reading Conversions	55
13. Recycling and Disposal (EC Countries).....	56
14. Warranty Information.....	57
15. Index	58

Important Notice



The following important information must be read and understood by all users of Cygnus ultrasonic thickness gauges.

The correct use of Cygnus ultrasonic thickness gauges requires identification of the correct equipment for the specific application coupled with an appropriately trained and qualified operator or technician. The incorrect use of this equipment, along with its incorrect calibration, can result in serious financial loss due to damage to components, facilities, personal injury and even death.

Neither Cygnus Instruments nor any of its employees or representatives can be held responsible for improper use of this equipment. Proper training, a complete understanding of ultrasonic wave propagation, thorough reading of this manual, proper transducer selection, correct zeroing of the transducer, correct sound velocity, correct use of the appropriate test blocks, proper cable length and proper couplant selection all play a factor in successful ultrasonic thickness gauging. Of critical importance is the process of complete and accurate calibration of the instrument.

This manual will provide instructions in the set up and operation of the thickness gauge. Additional factors that can affect the use of ultrasonic equipment are beyond the scope of this manual and to that end it is understood that the operator of this equipment is a well-trained inspector qualified by either their own organisation or another outside agency to the appropriate level of both theory and practical application of ultrasonics .

Therefore Cygnus Instruments recommends that users of its ultrasonic thickness gauges should be formally qualified to a minimum of UT "Level 1" (ASNT or PCN) which will provide approximately 40 hours of training.

1. Introduction

Cygnus 4 Thickness Gauge

The **Cygnus 4 Ultrasonic Thickness Gauge** is a rugged, handheld, battery-powered instrument designed for high-reliability multiple echo thickness measurements in harsh environments using ultrasound.

The gauge can be used with a choice of Ultrasonic Probes, selected to suit the material and thickness range to be measured.

The gauge measures material thickness using the Multiple Echo technique giving quick, reliable measurements through surface coatings which are ignored.

Measurements can be displayed in either Metric (mm) or in Imperial (inch) units. The gauge has an side mounted sunlight readable LCD graphic display which can be easily read in most light situations.

The gauge can easily be calibrated to a known thickness or to a known Velocity of Sound.

The gauge is able to operate accurately over a wide range of ambient temperatures and is environmentally sealed to IP67 for use in wet conditions.



The gauge is a solid-state electronic instrument which, under normal operating conditions, will give many years of active service.

Although designed for ease of operation the first time user should carefully read this manual to familiarise themselves with the features of the Gauge.

Cygnus Instruments

Cygnus Instruments Limited, founded in 1983, pioneered the development of the Digital *Ultrasonic Multiple-Echo Technique* used for measurement through coatings. This has long since been the standard required to ensure that accurate measurements are taken without the need to zero the gauge or remove any coatings first.

Our philosophy is to work closely our customers to provide high quality products, engineered to serve heavy industry & harsh environments. Cygnus Ultrasonic thickness gauges are designed to be reliable and simple to use. We have an unrivalled reputation in over 45 countries around the world.



CYGNUS Instruments Ltd.

Cygnus House, 30 Prince of Wales Road,
Dorchester, Dorset, DT1 1PW England.
Website: www.cygnus-instruments.com
Tel: 00 44 (0) 1305 265533
Fax: 00 44 (0) 1305 269960
sales@cygnus-instruments.com

Cygnus UAE Cygnus Instruments Middle East

P.O. Box 127267
Jebel Ali Free Zone (JAFZA)
Dubai, UAE
Website: www.cygnus-instruments.com
Telephone: +971 50 3459305
E-mail: sales@cygnus-instruments.com

CYGNUS Instruments Inc.

Cygnus Instruments, Inc.
6900 Phillips Hwy, Suite 8
Jacksonville, FL 32216, USA.
Tel: 00 1 410 267 9771
Fax: 00 1 410 268 2013
www.cygnusinstruments.com
sales@cygnusinstruments.com

CYGNUS Singapore (S) Pty. Ltd.

63 Jalan Pemimpin
#04-01 Pemimpin Industrial Building
Singapore 577219
Tel : (+65) 6252 5909
Fax : (+65) 6251 1318
www.cygnus-instruments.sg
sales@cygnus-instruments.sg

Gauge Kit Contents

1. Cygnus 4 Gauge
2. Operating Manual (in side pouch)
3. Neck Strap (in side pouch)
4. Ultrasonic Probe
5. Moulded Probe Cable (in side pouch)
6. Accessory Pouch, containing;
 - 3 x AA Batteries
 - Blue Couplant Gel.
 - 15mm (or 1/2") Steel Test Block
 - Spare Membranes
 - Membrane Key
 - Membrane Couplant



2. Gauge Preparation

The gauge is supplied ready to use out of the box. Just insert the batteries, connect the probe to the gauge, turn on the power and you are ready to take thickness measurements.

Fitting the Batteries

The gauge requires 3 x AA/LR6/UM3 Batteries. Cygnus supplies and recommends Duracell Alkaline batteries. The batteries are located behind a cover on the rear of gauge. The hand strap can be separated by a push-button buckle to gain access to the battery cover. The battery cover is removed by pressing in with your thumb the at the base to release the clip.



Press the bottom of the battery cover to release the retaining clip and lift up the battery cover.



The batteries are located underneath.

The gauge is protected against electrical damage from incorrect battery insertion.

The battery compartment itself is sealed to contain any battery fluids that may leak out.



The gauge can be fitted with NiCad or NiMH rechargeable batteries but this may alter the specified operating time.

 To avoid damage from leaking batteries **always** remove the batteries if the gauge will be unused for any length of time.

If the batteries run flat they may leak acid into the battery compartment and damage the electrical contacts. This would not be covered by the warranty.

Connecting the Probe

The Cygnus probe lead uses a custom made cable that offers superior flexibility and resistance to oils and ultraviolet light. The cable will not stiffen after exposure to ultraviolet light.

The connector uses original Lemo connectors for reliability.

Depending on the type of probe supplied the probe end will have either a BNC or single Lemo 00 connector.



To release the connector simply pull back on the connector body. DO NOT pull the cable.

Fitting the Neck Strap

The gauge is supplied with an adjustable Neck Strap. The ends of the neck strap clip onto two wire loops fitted to the gauge. These wire loops are made from coated stainless steel.



Wire loop fitted to the gauge body.

Simply pass the loop through the hole in the gauge and back over the other end.

The neck strap can then be clipped on to the loops.

3. Selecting the Right Probe

The performance of any thickness gauge, and its ability to get a reliable measurement depends on selecting the right ultrasonic probe for the application and conditions. Cygnus gauges are therefore offered with a selection of probes suitable for most thickness gauging applications.

The following section helps you select the right probe for the application.

 The gauge **must** be set for the probe connected to it.

The probe type is displayed at the top of the measurement screen in the status area.



Probe Type set to S2C.

Measuring Metals

Material	Coating	Corrosion	Thickness	Recommended..	
				Probe	Measurement Mode
Steels	Any	Non to Moderate	1 mm+	S5A	Multiple Echo
Steels	Any	Non to Moderate	2 mm+	S3C	Multiple Echo
Steels	Any	Non to Moderate	3 mm+	S2C	Multiple Echo

The S2C probe is suitable for most applications.

 When measuring in Multiple Echo mode the coating will be ignored and just the metal thickness measured.

Measurement Modes Explained and Compared

Multiple Echo Mode (Mode 3)

Multiple Echo measurement mode is by far the most reliable and easy method for thickness measurements, because it works by looking for three matched echoes it can verify the thickness measurement is valid. This method has been used in all Cygnus gauges since the late 1970s.

Multiple echo mode will ignore surface coatings, there is no need to remove the paint to take a measurement.

Also because it uses a single element (or single crystal) probe there are no errors due to the V-path of the ultrasound beam found in all twin element probes. This makes it simple to calibrate – two point calibrations are not required.

However because it requires three echoes to take a measurement, in heavily corroded steels there is often an insufficient number of echoes so no measurement is possible.

Measuring Non-Steels

The gauge will measure the following non-steels;

- Aluminium alloys
- Copper and Brass alloys
- Titanium

Use the same rules as steels when selecting a suitable probe. The gauge will ideally be re-calibrated to suit the metal being measured, or the standard velocity of sound for that material would be entered into the gauge.

Measuring Non-Metals

The gauge is not suitable for measuring non-metals. Typically these materials cannot be measured with this gauge model;

- Plastics
- Concrete

- Wood
- Thermal insulation materials
- Foams
- Composites

Single Element Probes and Protective Membranes

All Cygnus single element probes have a soft face and are therefore fitted with a Polyurethane Membrane which provides better contact on rough surfaces and protects the probe face from wear, prolonging the life of the probe.

-  Check the membrane regularly as it is important the membrane is changed as soon as it shows any signs of wear.

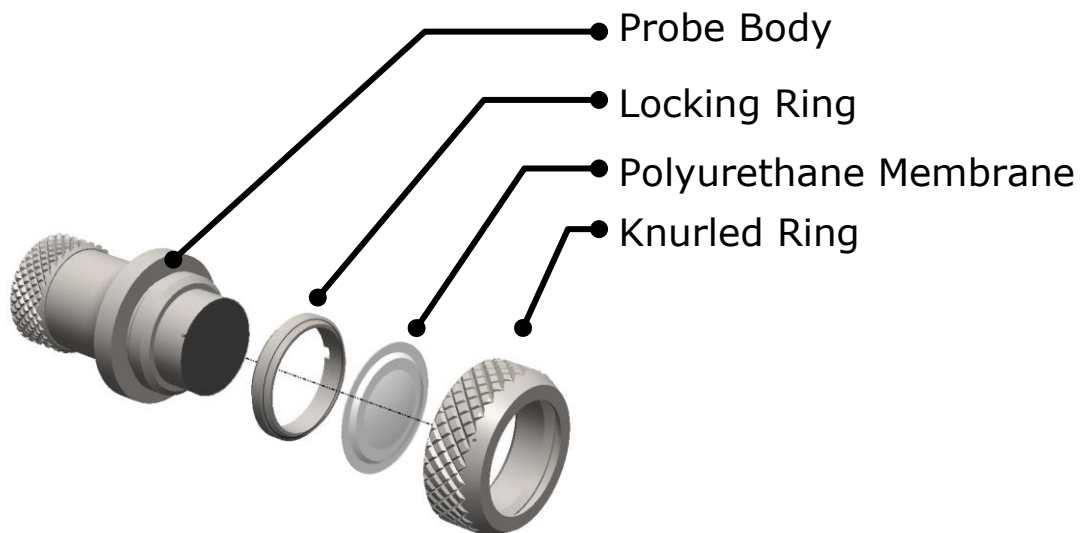



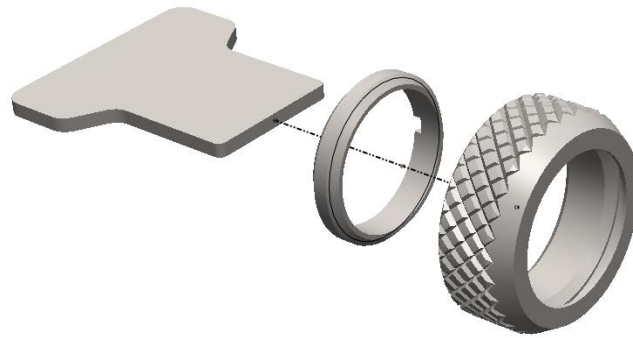

Single Element Probe Membrane Parts.

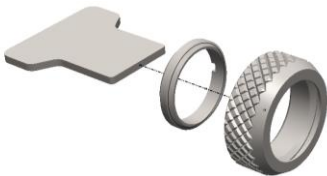
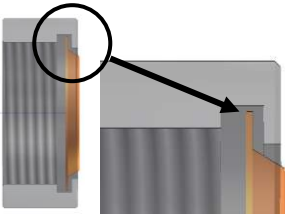
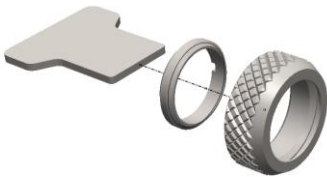

Single Element Probe Membrane Locking Key

Changing the Protective Membrane on Single element Probes

<p>1.</p>	<p>Unscrew the Knurled Ring from the end of the Probe.</p>	
<p>2.</p>	<p>Use the Membrane Key to unscrew the Locking Ring from inside the Knurled Ring. The old membrane can then be removed and discarded.</p>	
<p>3.</p>	<p>Place a new membrane into the end of the Knurled Ring ensuring it locates in the groove.</p>	
<p>4.</p>	<p>Screw the Locking Ring back inside the Knurled Ring and tighten with the Membrane Key.</p>	
<p>5.</p>	<p>Place a few drops of Membrane Couplant on to the probe face.</p>	
<p>6.</p>	<p>Screw the Knurled Ring back onto the probe. Use your thumb to squeeze the couplant from under the membrane as you tighten the Knurled Ring down.</p>	
<p>7.</p>	<p>You should see the membrane has a very thin film of couplant between itself and the probe face with <u>no air bubbles</u>.</p>	

Measuring Higher Temperatures

The polyurethane membranes fitted to the single element probes are suitable for measuring surface temperatures up to **70°C** (160°F). For measuring higher temperatures Teflon membranes are available and suitable for surface temperatures up to **150°C** (300°F) with intermittent contact. Contact Cygnus instruments to order Teflon membranes.

When measuring high temperatures limit the time the probe is in contact with the hot surface to less than 4 seconds and ensure the probe has sufficient time between measurements to cool down.

Summary of Cygnus Probes

Single Element probes

Probe Type	Size	Frequency	Range in Steel	Typical Uses
S2C	13mm	2.25 MHz	3 to 250 mm	General purpose probe suitable for most applications that can use Multiple Echo measurement. Coated metals
S3C	13mm	3.5 MHz	2 to 150 mm	Coated metals
S5C	13mm	5.0 MHz	1 to 50 mm	Coated metals
S5A	6mm	5.0 MHz	1 to 50 mm	Small diameter tubes Thin metals Coated metals

The 'Probe Type' Code

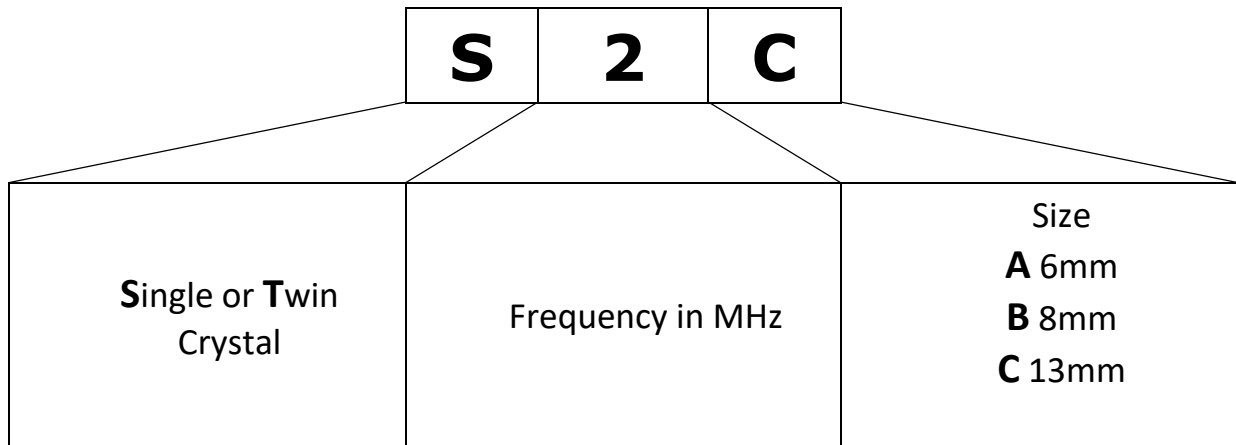



4. Gauge Operation

Gauge Controls

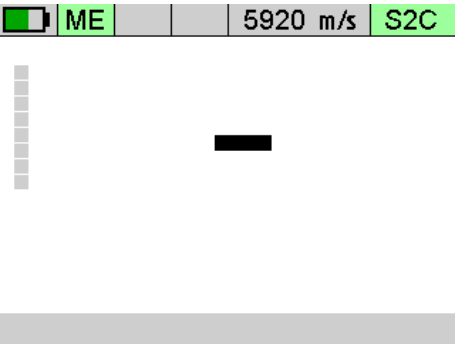

Turning the Gauge On

1.	Press the Power key	
2.	Cygnus Instruments Logo is displayed	
3.	The gauge details are displayed; Model Serial Number Version Number Run Time	 <p> MODEL : M5-C4 SERIAL No : 11000 VERSION : v1.92B-R395-C02 RUN TIME : 26h 22m Read Manual Before Use. Full Warranty Terms can be found at www.cygnus-instruments.com </p>
4.	The gauge is ready to use	 <p> ME 5920 m/s S2C </p>

Turning the Gauge Off

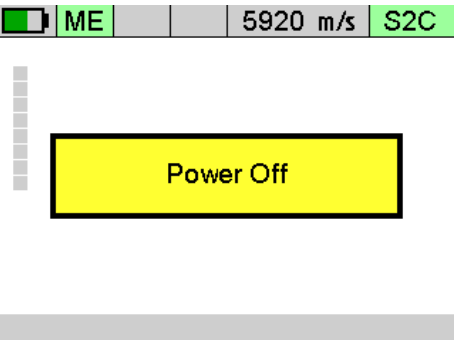
1.	Press & Hold the Power key,	
2.	The display shows 'power-off' and the gauge turns off.	 <p> ME 5920 m/s S2C </p> <p>Power Off</p>

Automatic Power Off

By default the gauge will turn off automatically after 5 minutes of in activity.

Taking thickness measurements or accessing the menu will reset the activity timer back to zero.

You can change the activity time value the Setup menu, see Power Off Setting on page 43.

Status Information

At the top of the display is an area that shows information about the gauge's status;

- Battery Level
- Velocity of Sound value / Calibration Status
- Probe Type
- Measurement Mode
- Deep Coat Function

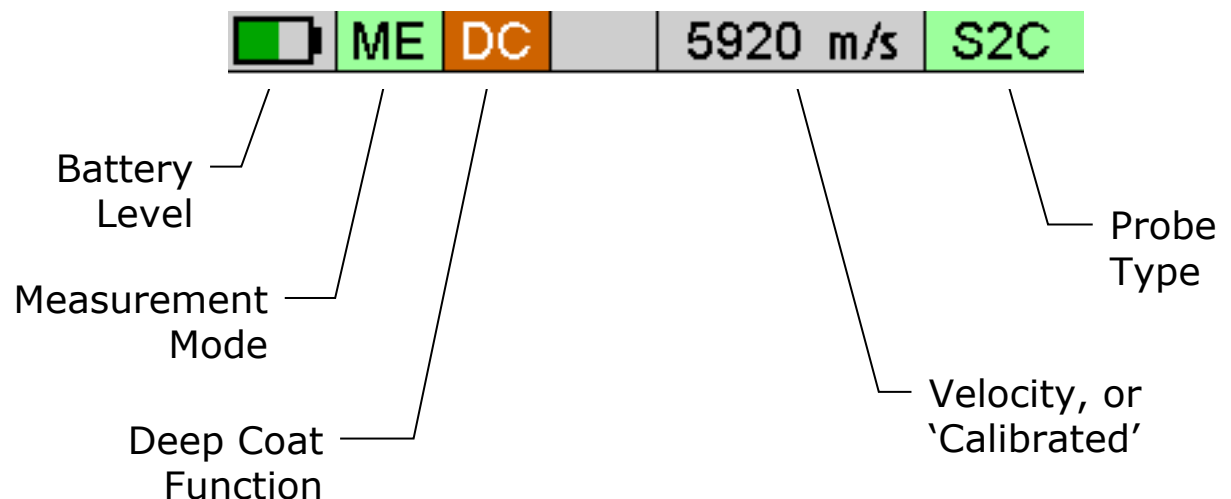

Probe Type; when the probe is connected the background colour is green, when disconnected it is grey.

Taking Thickness Measurements

Taking ultrasonic thickness measurements is a straight forward process that involves first making sure the surface is clean and prepared, applying an ultrasonic couplant gel then placing the probe on the surface and observing the display for the measurement.

Taking the Thickness Measurement

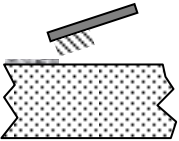
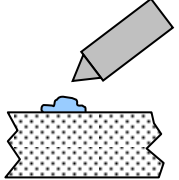
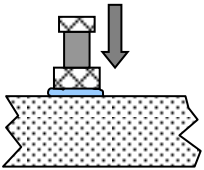
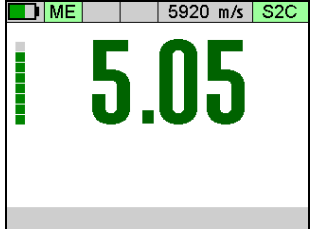
<p>1.</p>	<p>Remove all scale, rust, dirt or loose coatings and brush the test area clean.</p>	
<p>2.</p>	<p>Apply ultrasonic couplant to the test surface.</p>	
<p>3.</p>	<p>Place the probe-face on the clean, lubricated test surface and make firm contact applying gentle pressure.</p>	
<p>4.</p>	<p>The gauge will display a thickness measurement. Or an indication of Echo Strength if no valid measurement has been found.</p>	

Echo Indicators in Multiple Echo Mode

Should the gauge be unable to detect a stable multiple echo signal it displays an Echo indication to help the operator locate a suitable position.

<p>1.</p>	<p>1 Bar Flashing: <i>No echoes detected</i></p>	
------------------	--	--

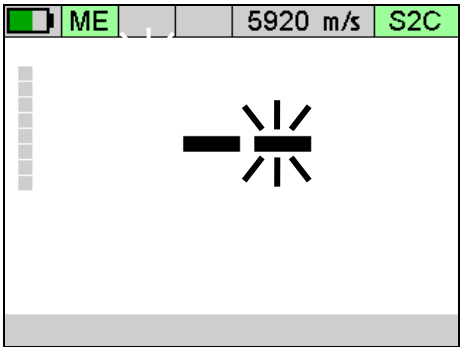
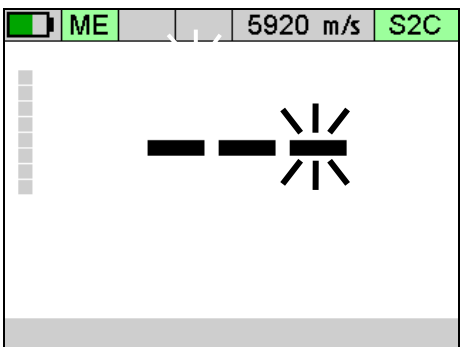
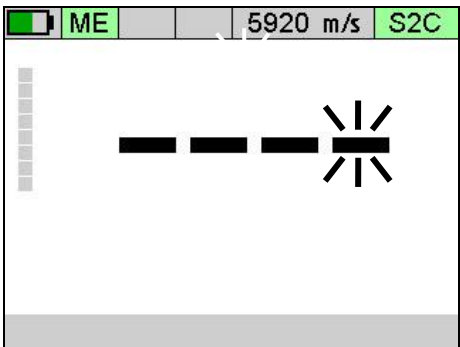
<p>2.</p>	<p>1 steady + 1 Bar Flashing: <i>Only 1 echo detected</i></p>	
<p>3.</p>	<p>2 steady + 1 Bar Flashing: <i>Only 2 echoes detected</i></p>	
<p>4.</p>	<p>3 steady + 1 Bar Flashing: <i>3 echoes detected but they are not matched</i></p>	

To help obtain a multiple echo reading the operator should continue to move the probe around to locate a suitable reflector, using a slight rocking motion.

Display Hold Function

The thickness measurement can be 'Held' or frozen by simply pressing the X/Cancel key while in the measurement screen.

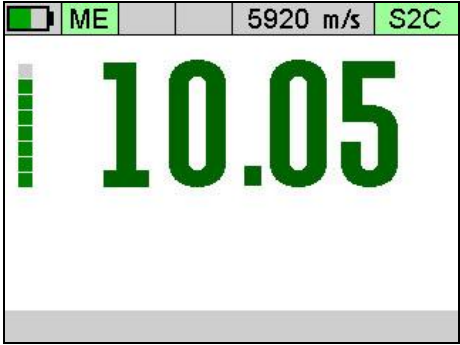
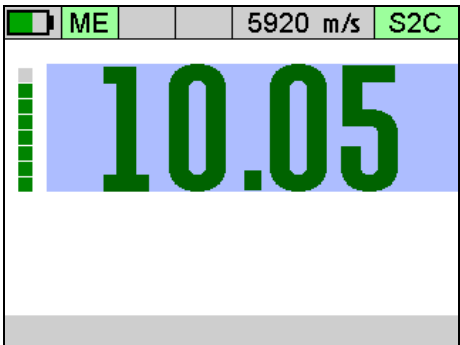
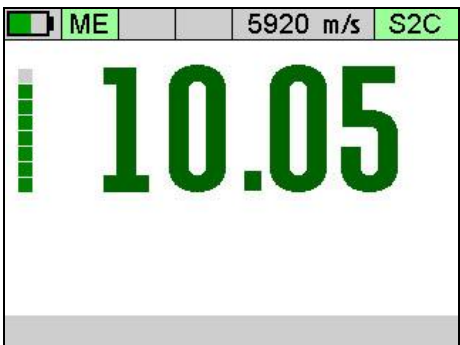
<p>1.</p>	<p>A thickness measurement is displayed</p>	
<p>2.</p>	<p>Press the X/Cancel key to hold the thickness measurement.</p> <p>The measurement value now has a light blue border to indicate its held or froze.</p>	
<p>3.</p>	<p>Press the X/Cancel key to un-hold the thickness measurement.</p>	

Battery Life

The gauge will operate continuously for approximately 10 hrs when fitted with Duracell Alkaline 1500 mA/hr batteries.

Battery Level

A battery level graphic is displayed at the top left position of the display (arrowed);

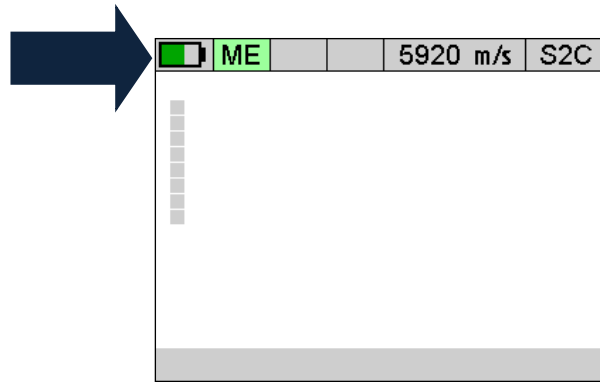

Battery almost full	
Battery about 1/2 full	
Battery low	

Low Battery Indication

The gauge will periodically flash a red Low Battery warning sign when the batteries have approximately 1 hour of use remaining.

Low battery indication	
------------------------	--

When the batteries are exhausted the gauge will display a **Flat Battery** message for 5 seconds then turn off automatically.

Flat Battery message	
----------------------	--

5. Calibration

Why should I Calibrate my Thickness Gauge?

Ultrasonic thickness gauges measure time in order to measure the thickness of the material being tested. They rely on the principle that sound travels through a material at a constant velocity or speed. If you can accurately measure the time it takes to travel through a material and you know its velocity then you can calculate its thickness;

$$\text{Thickness} = \frac{\text{time} \times \text{velocity}}{2}$$

Modern thickness gauges are easily capable of measuring **time** accurately to 10 nano seconds (0.000,000,01 seconds) so this is considered to be more than sufficiently accurate.

This means the accuracy of any thickness gauge measurement relies principally on the **velocity** being correct for the material being measured.

There are tables listing the velocity of most common metals and materials, but these velocities are only "typical" values. For example Mild Steel has a typical velocity of 5920 m/s – but in practice when measuring a variety of mild steel samples the velocity can range anywhere from 5860 to 5980 m/s.

This means if you want to achieve the most accurate thickness measurements you must calibrate your thickness gauge to a sample of the same material you will be testing – and a sample that you can accurately measure the thickness of with a Vernier or micrometer.

Your measurements are only as good as your calibration

Instructions for calibrating the gauge can be found on page 26 onwards.

Calibration Options

The Gauge is supplied tested and calibrated. The Gauge will have been calibrated to measure thickness through steel (grade S355JO) with a velocity of sound of 5920 m/s.

Either a 15mm or 1/2" **Test Block** is supplied with the kit so the Gauge can be quickly checked for correct operation. Note, this test block is not intended to be used for calibration of the Gauge.



The best way to calibrate the Gauge is to [Calibrate using a Known Thickness](#) using a sample of the material you intend to measure. This method determines the velocity of sound for the material sample, which will always be more accurate than using a 'general' velocity value. For calibration instructions see page 26.

If there is no test sample available the Gauge can be calibrated by [Setting the Velocity of Sound](#) directly. A [table](#) on page 54 at the back of this manual lists common materials and their velocity of sound value. For calibration instructions see page 27.



A third method is to leave the Gauge set to its factory-preset value for Steel [5920 m/s or 0.2332 in/us], and then use a Conversion Factor from the [table of velocities](#) on page 54.

Calibrating to a known thickness (Single or 1 Point)

This method of calibrating the gauge is more accurate than using a standard velocity value as the gauge calculates the velocity of sound for the sample material.

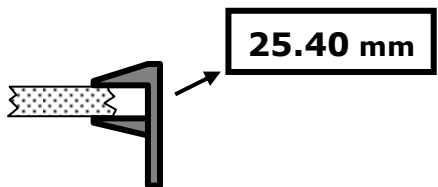
You can use this calibration method for all measurement modes.

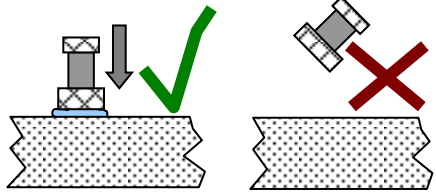
<p>1.</p>	<p>Accurately measure the thickness of your sample material.</p>	
------------------	--	--

<p>2.</p>	<p>Place the Probe on the sample and verify the gauge can get a thickness value.</p>																			
<p>3.</p>	<p>Access the Menu and scroll down to the 'Calibration' group. Then scroll right to the '1 Point Cal' item.</p> <p>Press the Ok/Select key to open the '1 Point Cal' function</p>	<table border="1" style="width: 100%; border-collapse: collapse;"> <tr> <td colspan="2" style="text-align: right;">Main Menu</td> <td style="text-align: right;">15:21:19</td> </tr> <tr> <td>Measurement</td> <td colspan="2">1 Point Cal</td> </tr> <tr> <td>Limits</td> <td>Velocity</td> <td style="text-align: right;">5926</td> </tr> <tr> <td>Probe</td> <td colspan="2">Material</td> </tr> <tr> <td style="background-color: #0056b3; color: white;">Calibration</td> <td colspan="2"></td> </tr> <tr> <td>Setup</td> <td colspan="2"></td> </tr> </table> <p style="font-size: small;">Perform a calibration on a material sample of known thickness.</p>	Main Menu		15:21:19	Measurement	1 Point Cal		Limits	Velocity	5926	Probe	Material		Calibration			Setup		
Main Menu		15:21:19																		
Measurement	1 Point Cal																			
Limits	Velocity	5926																		
Probe	Material																			
Calibration																				
Setup																				
<p>4.</p>	<p>While holding the probe firmly on the sample, and while a steady thickness measurement is displayed..</p>	<table border="1" style="width: 100%; border-collapse: collapse;"> <tr> <td style="text-align: center;">Calibration 1 Point</td> <td style="text-align: right; background-color: #90EE90;">S2C</td> </tr> <tr> <td style="text-align: center; font-size: 2em; color: green;">20.00</td> <td></td> </tr> <tr> <td colspan="2" style="text-align: center;">Velocity :5925</td> </tr> <tr> <td colspan="2" style="font-size: x-small;">Use the UP and DOWN keys to adjust the thickness measurement to the correct value Press ✓ to save X to cancel</td> </tr> </table>	Calibration 1 Point	S2C	20.00		Velocity :5925		Use the UP and DOWN keys to adjust the thickness measurement to the correct value Press ✓ to save X to cancel											
Calibration 1 Point	S2C																			
20.00																				
Velocity :5925																				
Use the UP and DOWN keys to adjust the thickness measurement to the correct value Press ✓ to save X to cancel																				
<p>5.</p>	<p>...use the Up and Down keys to adjust the thickness to the required value.</p>																			
<p>6.</p>	<p>When done press the OK/Select key to save the calibration. A Calibration Saved message will be shown.</p> <p>Or press the X/Cancel key to exit without saving the calibration.</p>	<table border="1" style="width: 100%; border-collapse: collapse;"> <tr> <td style="text-align: center;">Calibration 1 Point</td> <td style="text-align: right; background-color: #90EE90;">S2C</td> </tr> <tr> <td style="text-align: center; font-size: 2em; color: green;">20.00</td> <td></td> </tr> <tr> <td colspan="2" style="text-align: center; background-color: yellow; border: 2px solid black; padding: 5px;">Calibration Saved</td> </tr> <tr> <td colspan="2" style="font-size: x-small;">Use the UP and DOWN keys to adjust the thickness measurement to the correct value Press ✓ to save X to cancel</td> </tr> </table>	Calibration 1 Point	S2C	20.00		Calibration Saved		Use the UP and DOWN keys to adjust the thickness measurement to the correct value Press ✓ to save X to cancel											
Calibration 1 Point	S2C																			
20.00																				
Calibration Saved																				
Use the UP and DOWN keys to adjust the thickness measurement to the correct value Press ✓ to save X to cancel																				

When a Calibration has been made a '1PC' indicator is displayed at the top of the measurement screen in the status area (1PC = Single Point Calibration).



'1PC' Indicator

Setting the Velocity of Sound

The gauge uses the Velocity of Sound value to calculate the material thickness value. It is therefore important the velocity value is set for the material being measured.

! If you perform a Calibration the Velocity of Sound will be set for you during the calibration – so you don't need to adjust it afterwards.

You can manually set the velocity of sound value if required, normally you would do this if;

- You can't perform a calibration
- You want to use the same velocity setting as last time
- You want to use a velocity from a material list

A list of velocity of sound values for common material can be found on page 54.

<p>1. Access the Menu and scroll down to the 'Calibration' group. Then scroll right and select 'Velocity'.</p> <p>Press the Ok/Select key to open the 'Velocity' function</p>	<p>Main Menu 15:50:19</p>									
	<table border="1" style="width: 100%; border-collapse: collapse;"> <tr> <td style="padding: 2px;">Measurement</td> <td style="padding: 2px;">1 Point Cal</td> </tr> <tr> <td style="padding: 2px;">Limits</td> <td style="padding: 2px;">Velocity 5926</td> </tr> <tr> <td style="padding: 2px;">Probe</td> <td style="padding: 2px;">Material</td> </tr> <tr> <td style="padding: 2px;">Calibration</td> <td style="padding: 2px;"></td> </tr> <tr> <td style="padding: 2px;">Setup</td> <td style="padding: 2px;"></td> </tr> </table>	Measurement	1 Point Cal	Limits	Velocity 5926	Probe	Material	Calibration		Setup
Measurement	1 Point Cal									
Limits	Velocity 5926									
Probe	Material									
Calibration										
Setup										
<p>Adjust or set the velocity of sound value.</p>										

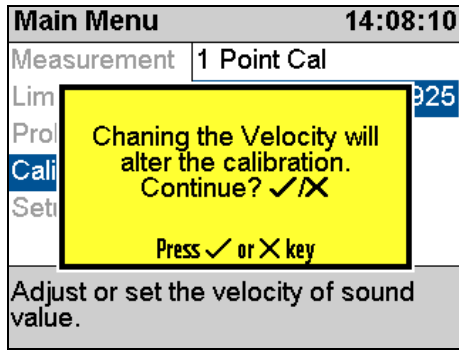
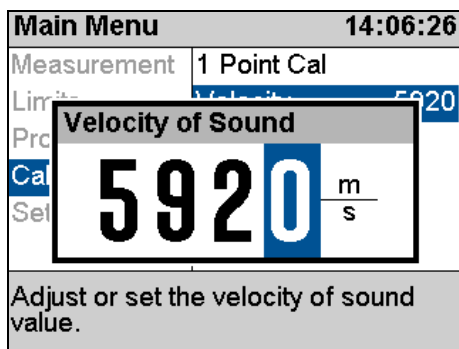
<p>2.</p>	<p>If there has been a previous Calibration a message will warn that changing the velocity will alter the calibration;</p> <p>Press the OK/Select key to continue, or X/Cancel to abort.</p>	
<p>3.</p>	<p>Use the Up and Down keys to adjust the velocity value as required</p> <p>Use the Left and Right keys to highlight the digit to change.</p>	
<p>4.</p>	<p>When done press the OK/Select key to save the changes.</p> <p>Or press the X/Cancel key to exit without saving.</p>	



When the velocity has been manually set the value is displayed at the top of the measurement screen in the status area.







Velocity of Sound value '5920 m/s'

6. Gauge Setup

Menu Operation

<p>1.</p>	<p>Press the Menu key,</p>																						
<p>2.</p>	<p>the Main Menu is displayed</p>	<table border="1"> <tr> <td colspan="2">Main Menu</td> <td style="text-align: right;">14:04:16</td> </tr> <tr> <td>Measurement</td> <td>Units</td> <td>mm</td> </tr> <tr> <td>Limits</td> <td>Resolution</td> <td>0.1</td> </tr> <tr> <td>Probe</td> <td>Deep Coat</td> <td>Off</td> </tr> <tr> <td>Calibration</td> <td></td> <td></td> </tr> <tr> <td>Setup</td> <td></td> <td></td> </tr> <tr> <td colspan="3">Measurement settings; mode, units, resolution.</td> </tr> </table>	Main Menu		14:04:16	Measurement	Units	mm	Limits	Resolution	0.1	Probe	Deep Coat	Off	Calibration			Setup			Measurement settings; mode, units, resolution.		
Main Menu		14:04:16																					
Measurement	Units	mm																					
Limits	Resolution	0.1																					
Probe	Deep Coat	Off																					
Calibration																							
Setup																							
Measurement settings; mode, units, resolution.																							
<p>3.</p>	<p>Use the four Navigation keys to scroll around the Main Menu</p>																						
<p>4.</p>	<p>Use the Up and Down keys to select a group in the left column..</p>	<table border="1"> <tr> <td colspan="2">Main Menu</td> <td style="text-align: right;">14:04:21</td> </tr> <tr> <td>Measurement</td> <td>Limits</td> <td>Off</td> </tr> <tr> <td>Limits</td> <td>Minimum</td> <td>0.0</td> </tr> <tr> <td>Probe</td> <td>Reference</td> <td>0.0</td> </tr> <tr> <td>Calibration</td> <td>Maximum</td> <td>250.0</td> </tr> <tr> <td>Setup</td> <td>Vibrate</td> <td>Off</td> </tr> <tr> <td colspan="3">Limits, reference, minimum and maximum thickness values with alarm option.</td> </tr> </table>	Main Menu		14:04:21	Measurement	Limits	Off	Limits	Minimum	0.0	Probe	Reference	0.0	Calibration	Maximum	250.0	Setup	Vibrate	Off	Limits, reference, minimum and maximum thickness values with alarm option.		
Main Menu		14:04:21																					
Measurement	Limits	Off																					
Limits	Minimum	0.0																					
Probe	Reference	0.0																					
Calibration	Maximum	250.0																					
Setup	Vibrate	Off																					
Limits, reference, minimum and maximum thickness values with alarm option.																							
<p>5.</p>	<p>Press the Right key to move to the items in that group in the right column. Then use the Up and Down keys to select from the right column</p>	<table border="1"> <tr> <td colspan="2">Main Menu</td> <td style="text-align: right;">14:05:36</td> </tr> <tr> <td>Measurement</td> <td>Limits</td> <td>Off</td> </tr> <tr> <td>Limits</td> <td>Minimum</td> <td>5.0</td> </tr> <tr> <td>Probe</td> <td>Reference</td> <td>15.0</td> </tr> <tr> <td>Calibration</td> <td>Maximum</td> <td>250.0</td> </tr> <tr> <td>Setup</td> <td>Vibrate</td> <td>Off</td> </tr> <tr> <td colspan="3">Turn Limits On or Off</td> </tr> </table>	Main Menu		14:05:36	Measurement	Limits	Off	Limits	Minimum	5.0	Probe	Reference	15.0	Calibration	Maximum	250.0	Setup	Vibrate	Off	Turn Limits On or Off		
Main Menu		14:05:36																					
Measurement	Limits	Off																					
Limits	Minimum	5.0																					
Probe	Reference	15.0																					
Calibration	Maximum	250.0																					
Setup	Vibrate	Off																					
Turn Limits On or Off																							

<p>6.</p>	<p>If you want to change or select the item currently displayed simply press the green Ok/Select button</p>																						
<p>7.</p>	<p>Then use the Navigation keys to highlight the required setting or option</p>	<table border="1"> <tr> <td colspan="2">Main Menu</td> <td>14:04:56</td> </tr> <tr> <td>Measurement</td> <td>Limits</td> <td>Off</td> </tr> <tr> <td>Limits</td> <td>Minimum</td> <td>0.0</td> </tr> <tr> <td>Probe</td> <td>Enable Limits</td> <td>0.0</td> </tr> <tr> <td>Calibr</td> <td>Off</td> <td>250.0</td> </tr> <tr> <td>Setup</td> <td>On</td> <td>Off</td> </tr> <tr> <td colspan="3">Turn Limits On or Off</td> </tr> </table>	Main Menu		14:04:56	Measurement	Limits	Off	Limits	Minimum	0.0	Probe	Enable Limits	0.0	Calibr	Off	250.0	Setup	On	Off	Turn Limits On or Off		
Main Menu		14:04:56																					
Measurement	Limits	Off																					
Limits	Minimum	0.0																					
Probe	Enable Limits	0.0																					
Calibr	Off	250.0																					
Setup	On	Off																					
Turn Limits On or Off																							
<p>8.</p>	<p>Press the green Ok/Select key to save your choice</p>																						
<p>9.</p>	<p>Or press the red X/Cancel key to abort</p>																						
<p>10.</p>	<p>Press the Left key to go back to the main group if you want to make another selection</p>	<table border="1"> <tr> <td colspan="2">Main Menu</td> <td>14:04:21</td> </tr> <tr> <td>Measurement</td> <td>Limits</td> <td>Off</td> </tr> <tr> <td>Limits</td> <td>Minimum</td> <td>0.0</td> </tr> <tr> <td>Probe</td> <td>Reference</td> <td>0.0</td> </tr> <tr> <td>Calibration</td> <td>Maximum</td> <td>250.0</td> </tr> <tr> <td>Setup</td> <td>Vibrate</td> <td>Off</td> </tr> <tr> <td colspan="3">Limits, reference, minimum and maximum thickness values with alarm option.</td> </tr> </table>	Main Menu		14:04:21	Measurement	Limits	Off	Limits	Minimum	0.0	Probe	Reference	0.0	Calibration	Maximum	250.0	Setup	Vibrate	Off	Limits, reference, minimum and maximum thickness values with alarm option.		
Main Menu		14:04:21																					
Measurement	Limits	Off																					
Limits	Minimum	0.0																					
Probe	Reference	0.0																					
Calibration	Maximum	250.0																					
Setup	Vibrate	Off																					
Limits, reference, minimum and maximum thickness values with alarm option.																							
<p>11.</p>	<p>To exit the menu press the Menu or red X/Cancel key once.</p>																						





Settings are Saved with the Probe Type

Certain gauge settings are saved against the probe type. This allows each probe type to have different settings that will be recalled when that probe is re-connected and the probe type is correctly set. The following settings are saved with each probe type;

- Units
- Resolution
- Velocity of sound
- Calibration
- Deep Coat

Changing Numeric Values using the Navigation Keys

Some menu functions require the user to input a numeric value using the navigation keys. This is done 'digit' at a time, using the Left and Right keys to select the digit, then the Up and Down keys to change the highlighted digit's value.

<p>1.</p>	<p>The units digit is highlighted. Pressing Up or Down will change the units value only.</p>	
<p>2.</p>	<p>Pressing the Left key will move the highlight to the tens digit. Pressing Up or Down will change this value only.</p>	
<p>3.</p>	<p>Pressing the Left key will move the highlight to the hundreds digit. Pressing Up or Down will change this value only.</p>	
<p>4.</p>	<p>Pressing the Left key will move the highlight to the thousands digit. Pressing Up or Down will change this value only.</p>	

Selecting the Probe Type

-  The Probe Type must be set to the probe connected to it. If the wrong probe is selected the gauge will not measure accurately if at all.

The Probe Type is displayed is displayed at the top of the measurement screen in the status area. When a probe is connected the background is green. When no probe is detected the background is grey.



S2C Probe Selected and Connected



S2C Probe Selected but NOT Connected

<p>1. Access the Menu and scroll down to the 'Probe' group. Then scroll right and select 'Probe Type'.</p> <p>Press the Ok/Select key to open the 'Probe Type' function</p>		<p>Select the Probe Type to match the probe connected to the gauge or use Auto detect.</p>
<p>2. Use the Up and Down keys to select the Probe Type required</p>		<p>probe connected to the gauge or use Auto detect.</p>
<p>3. Press the OK/Select key to save.</p> <p>Or press the X/Cancel key to exit without saving.</p>		



Remember settings and calibration is saved with each probe type. So if you change the probe type you may find a setting has changed – this is normal.

The reason settings are saved with each probe type is so you can swap probes during a survey without having to re-calibrate each time.

Automatic Probe Detection

There is no automatic probe detection feature on this model of gauge. You must select if manually from the list of probes. See [Selecting the Probe Type](#) on page 33.

Measurement Units

The Gauge can display thickness measurements in either Metric (mm) or Imperial (inch). Changing the measurement units will not affect the calibration.

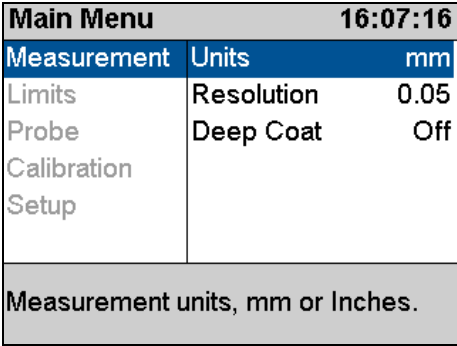
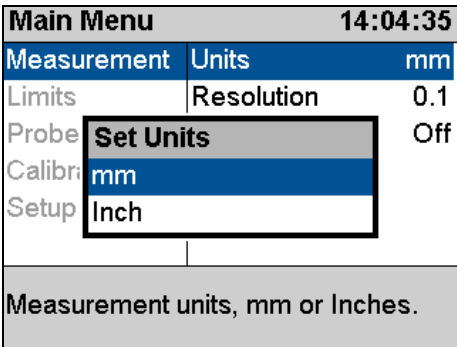
<p>1.</p>	<p>Access the Menu and scroll down to the 'Measurement' group. Then scroll right and select 'Units'.</p> <p>Press the Ok/Select key to open the 'Units' function</p>	
<p>2.</p>	<p>Use the Up and Down keys to switch from mm to Inch</p>	
<p>3.</p>	<p>Press the OK/Select key to save.</p> <p>Or press the X/Cancel key to exit without saving.</p>	

Resolution Setting

The gauge can display thickness measurements in two resolution settings:

- 0.1 mm 0.005 inch
- 0.05 mm 0.002 inch

For general metal corrosion measurement the 0.1 mm setting is recommended.

To change the Resolution setting:

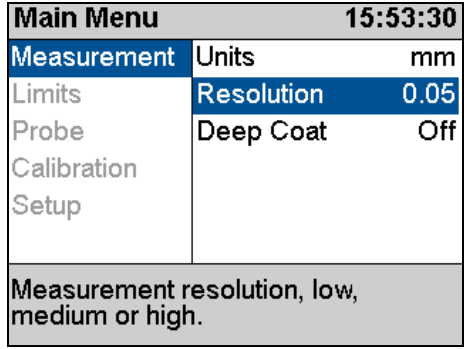
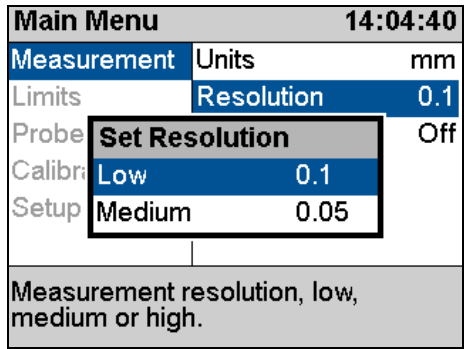
<p>1. Access the Menu and scroll down to the 'Measurement' group. Then scroll right and select 'Units'.</p> <p>Press the Ok/Select key to open the 'Resolution' function</p>		 <p>The screenshot shows the 'Main Menu' at 15:53:30. The 'Measurement' group is selected, and the 'Resolution' is set to 0.05. Other options include Units (mm), Limits, Probe (Deep Coat Off), Calibration, and Setup. A footer note reads: 'Measurement resolution, low, medium or high.'</p>
<p>2. Use the Up and Down keys to select the required Resolution</p>		 <p>The screenshot shows the 'Main Menu' at 14:04:40. The 'Resolution' is set to 0.1. A 'Set Resolution' dialog box is open, showing 'Low' (0.1) selected and 'Medium' (0.05) as an option. Other options include Units (mm), Limits, Probe (Off), Calibr, and Setup. A footer note reads: 'Measurement resolution, low, medium or high.'</p>
<p>3. Press the OK/Select key to save.</p> <p>Or press the X/Cancel key to exit without saving.</p>		

Limit Functions

The gauge has a Limit function that can be used to;

- Give visual indication of measurements between minimum, reference and maximum limits.
- Vibrate Alert the operator if measurements are outside the minimum or maximum limits

The Limit function can be turned ON or OFF as required and the Vibrate Alert can be enabled as required.

There are three Limit measurement values you can set;

- **Minimum** Limit – this is the lowest thickness measurement, measurements under this value will cause an Alert
- **Reference** Limit – this is the ‘correct’ thickness value, or when corrosion monitoring this is usually set to the thickness of the steel/material when it was new.
- **Maximum** Limit – this is the highest thickness measurement, measurements over this value will cause an Alert. *This limit is optional and can be set to zero.*

When Limits are enabled the measurement screen displays a horizontal bar-graph showing the limits and the current measurement in relation to these limits. The colour of the bar also changes from light green to dark green to red as the measurement moves from the reference value to the minimum or maximum limits.

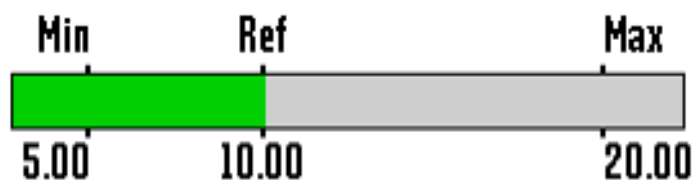

Thickness Measurement = Reference = Light Green Bar.

Limit Example

Limits are setup;

- Minimum = 5.00 mm
- Reference = 10.00 mm
- Maximum = 20.00 mm

The thickness measurement is 10.05 mm so the bar-graph shows a green bar positioned at the Reference point.

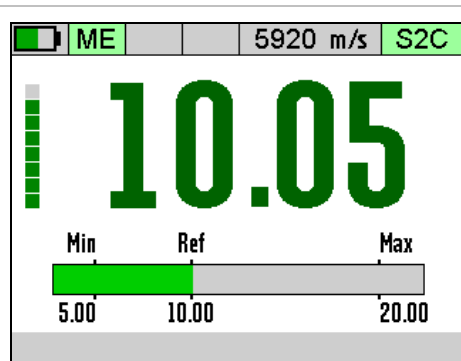

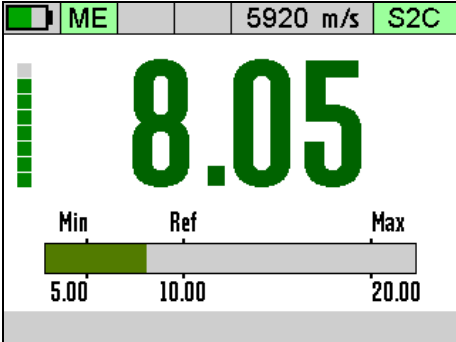
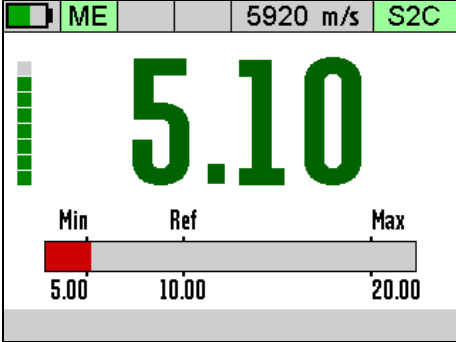
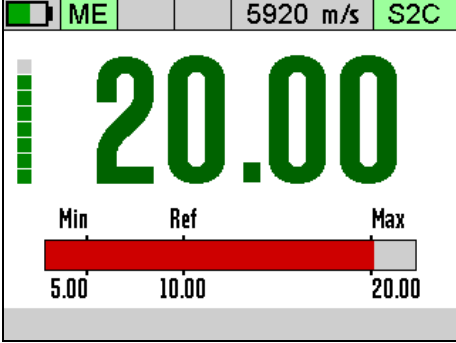
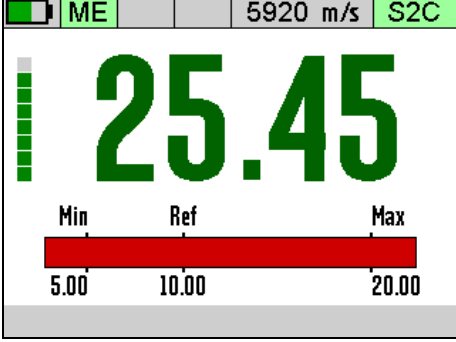
<p>Now the thickness measurement is 8.05 mm so the bar-graph shows a dark green bar positioned left of the Reference point.</p>	
<p>Now the thickness measurement is 5.10 mm so the bar-graph shows a red bar positioned at the Minimum point.</p>	
<p>Now the thickness measurement is 20.00 mm so the bar-graph shows a red bar positioned at the Maximum point.</p>	
<p>Now the thickness measurement is 25.45 mm so the bar-graph shows a red bar positioned past the Maximum point.</p> <p>This exceeds the Maximum limit so will cause an Vibrate Alert to the operator if enabled.</p>	

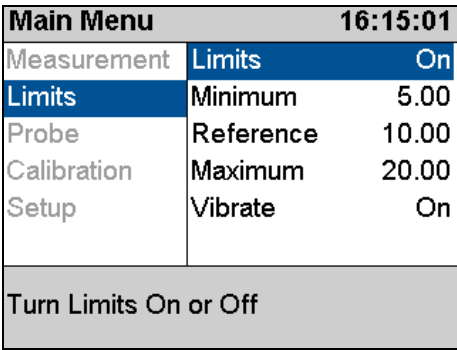
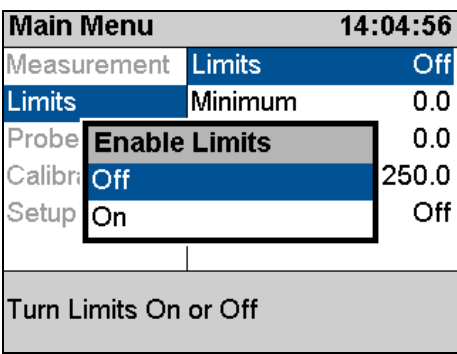
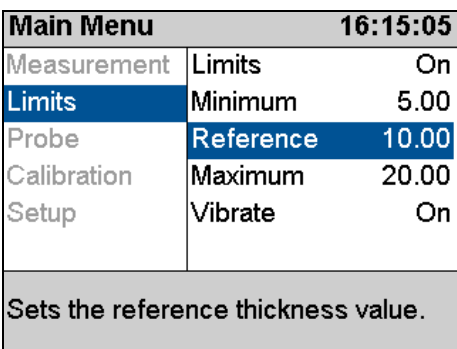
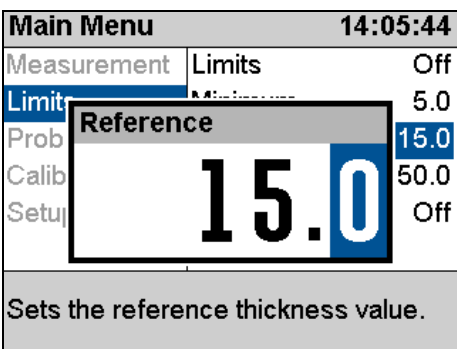
<p>1.</p>	<p>Access the Menu and scroll down to the 'Limits' group. Then scroll right and select 'Limits'.</p> <p>Press the Ok/Select key to open the 'Limits' function</p>	 <p>Main Menu 16:15:01</p> <table border="1"> <tr> <td>Measurement</td> <td>Limits</td> <td>On</td> </tr> <tr> <td>Limits</td> <td>Minimum</td> <td>5.00</td> </tr> <tr> <td>Probe</td> <td>Reference</td> <td>10.00</td> </tr> <tr> <td>Calibration</td> <td>Maximum</td> <td>20.00</td> </tr> <tr> <td>Setup</td> <td>Vibrate</td> <td>On</td> </tr> </table> <p>Turn Limits On or Off</p>	Measurement	Limits	On	Limits	Minimum	5.00	Probe	Reference	10.00	Calibration	Maximum	20.00	Setup	Vibrate	On
Measurement	Limits	On															
Limits	Minimum	5.00															
Probe	Reference	10.00															
Calibration	Maximum	20.00															
Setup	Vibrate	On															
<p>2.</p>	<p>Use the Up and Down keys to turn Limits On or Off...</p> <p>Press the OK/Select key to save. Or press the X/Cancel key to exit without saving.</p>	 <p>Main Menu 14:04:56</p> <table border="1"> <tr> <td>Measurement</td> <td>Limits</td> <td>Off</td> </tr> <tr> <td>Limits</td> <td>Minimum</td> <td>0.0</td> </tr> <tr> <td>Probe</td> <td>Reference</td> <td>0.0</td> </tr> <tr> <td>Calibr</td> <td>Off</td> <td>250.0</td> </tr> <tr> <td>Setup</td> <td>On</td> <td>Off</td> </tr> </table> <p>Turn Limits On or Off</p>	Measurement	Limits	Off	Limits	Minimum	0.0	Probe	Reference	0.0	Calibr	Off	250.0	Setup	On	Off
Measurement	Limits	Off															
Limits	Minimum	0.0															
Probe	Reference	0.0															
Calibr	Off	250.0															
Setup	On	Off															
<p>3.</p>	<p>Use the Up and Down keys to select the Minimum, Reference, Maximum or Vibrate settings</p> <p>Press the Ok/Select key to open the selected item</p>	 <p>Main Menu 16:15:05</p> <table border="1"> <tr> <td>Measurement</td> <td>Limits</td> <td>On</td> </tr> <tr> <td>Limits</td> <td>Minimum</td> <td>5.00</td> </tr> <tr> <td>Probe</td> <td>Reference</td> <td>10.00</td> </tr> <tr> <td>Calibration</td> <td>Maximum</td> <td>20.00</td> </tr> <tr> <td>Setup</td> <td>Vibrate</td> <td>On</td> </tr> </table> <p>Sets the reference thickness value.</p>	Measurement	Limits	On	Limits	Minimum	5.00	Probe	Reference	10.00	Calibration	Maximum	20.00	Setup	Vibrate	On
Measurement	Limits	On															
Limits	Minimum	5.00															
Probe	Reference	10.00															
Calibration	Maximum	20.00															
Setup	Vibrate	On															
<p>4.</p>	<p>Use the navigation keys to change the setting..</p> <p>Press the OK/Select key to save. Or press the X/Cancel key to exit without saving.</p>	 <p>Main Menu 14:05:44</p> <table border="1"> <tr> <td>Measurement</td> <td>Limits</td> <td>Off</td> </tr> <tr> <td>Limits</td> <td>Minimum</td> <td>5.0</td> </tr> <tr> <td>Probe</td> <td>Reference</td> <td>15.0</td> </tr> <tr> <td>Calib</td> <td>Off</td> <td>50.0</td> </tr> <tr> <td>Setup</td> <td>On</td> <td>Off</td> </tr> </table> <p>Sets the reference thickness value.</p>	Measurement	Limits	Off	Limits	Minimum	5.0	Probe	Reference	15.0	Calib	Off	50.0	Setup	On	Off
Measurement	Limits	Off															
Limits	Minimum	5.0															
Probe	Reference	15.0															
Calib	Off	50.0															
Setup	On	Off															

Deep Coat Function

With the Deep Coat turned Off the gauge can measure through most protective coatings up to 3 mm (0.11") thick when using a **S2C** type probe. Coatings like paint, anti-foul, hard plastics and epoxy should present no problems as long as they have not de-laminated/de-bonded from the metal surface.

With Deep Coat turned On this will allow the gauge to measure through coatings over 3mm (0.11”) thick up to a maximum of around 20 mm (0.78”) depending on the properties of the coating material.

Measuring through thick coatings is ultimately limited by how well the coating material allows the ultrasound to pass through, soft coatings like rubber or bitumen don’t transmit ultrasound very well.

Using Deep Coat will not affect the calibration.

 Turn Deep Coat Off when NOT measuring through thick coatings otherwise this may cause inaccurate measurements.

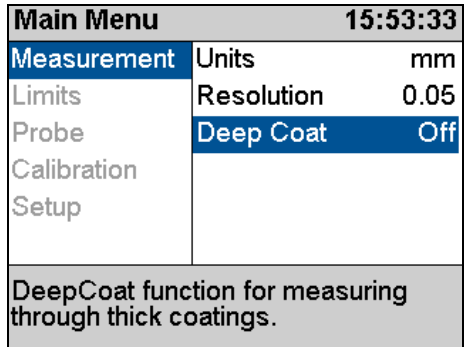
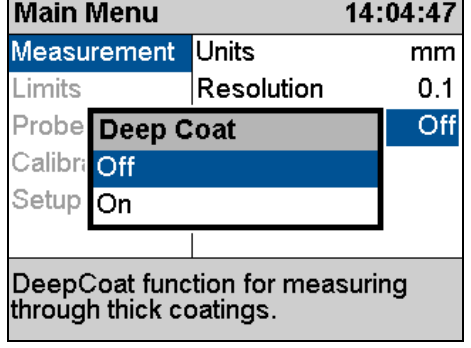
<p>1. Access the Menu and scroll down to the 'Measurement' group. Then scroll right and select 'Deep Coat'.</p> <p>Press the Ok/Select key to open the 'Deep Coat' option</p>		 <p>The screenshot shows the 'Main Menu' at 15:53:33. The 'Measurement' group is selected, showing 'Units' as 'mm', 'Limits' as 'Resolution 0.05', and 'Probe' as 'Deep Coat Off'. A note at the bottom states: 'DeepCoat function for measuring through thick coatings.'</p>
<p>2. Use the Up and Down keys to select Deep Coat On or Off</p>		 <p>The screenshot shows the 'Main Menu' at 14:04:47. The 'Measurement' group is selected, showing 'Units' as 'mm', 'Limits' as 'Resolution 0.1', and 'Probe' as 'Deep Coat Off'. A selection box highlights the 'Deep Coat' option, with 'Off' and 'On' visible below it. A note at the bottom states: 'DeepCoat function for measuring through thick coatings.'</p>
<p>3. Press the OK/Select key to save.</p> <p>Or press the X/Cancel key to exit without saving.</p>		

When Deep Coat is turned On a 'DC' indicator will be displayed in the status area at the top of the measurement screen.



DC = Deep Coat is ON.

7. Setup Menu

The Setup group is found at the bottom of the menu, it holds various gauge setup options.

<p>1. Access the Menu and scroll down to the 'Setup' group. Then scroll right to select the required item</p> <p>Press the Ok/Select key to open the highlighted item.</p>	Main Menu 15:53:59														
	<table border="1" style="width: 100%; border-collapse: collapse;"> <tr> <td style="padding: 2px;">Measurement</td> <td style="padding: 2px;">Vibrate</td> <td style="padding: 2px; text-align: right;">Off</td> </tr> <tr> <td style="padding: 2px;">Limits</td> <td style="padding: 2px;">Brightness</td> <td style="padding: 2px; text-align: right;">67%</td> </tr> <tr> <td style="padding: 2px;">Probe</td> <td style="padding: 2px;">Power Off</td> <td style="padding: 2px; text-align: right;">Normal</td> </tr> <tr> <td style="padding: 2px;">Calibration</td> <td style="padding: 2px;">Set Time</td> <td></td> </tr> <tr> <td style="padding: 2px;">Setup</td> <td style="padding: 2px;">Set Date</td> <td></td> </tr> </table>	Measurement	Vibrate	Off	Limits	Brightness	67%	Probe	Power Off	Normal	Calibration	Set Time		Setup	Set Date
Measurement	Vibrate	Off													
Limits	Brightness	67%													
Probe	Power Off	Normal													
Calibration	Set Time														
Setup	Set Date														
Vibrate Alert when a valid or stable thickness measurement is obtained.															

Vibrate Feature

The Vibrate feature will vibrate the gauge when a verified thickness measurement is found to alert the user. You can use this menu item to turn this On or Off as required.

Brightness Setting

The display brightness can be set Manually or Automatically using the ambient light level sensor.

 Higher brightness will consume more power so reduce the battery life. To maximum the battery life choose the lowest brightness that still allows you to read the display.

In Automatic mode the brightness is dimmed when in dark conditions and increased when in bright light conditions.

In Manual mode you can adjust the brightness over 20 levels, 0 is the lowest level.

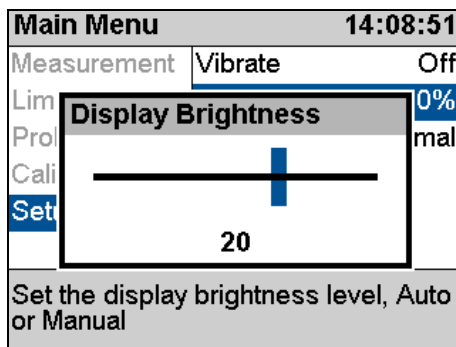

Manual Brightness Setting.

Power Off Setting

You can choose from three power-saving settings, these determine how long before the gauge will dim the display and ultimately turn off when the gauge is inactive (inactive = no key presses and no thickness measurements).

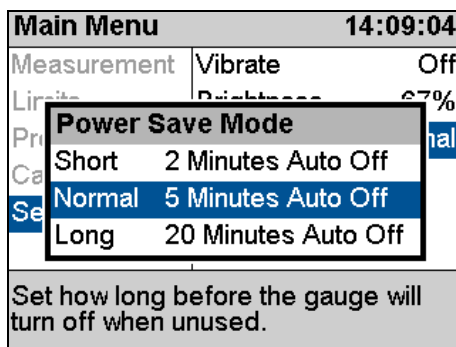

Power Save Modes.

Set Time and Set Date

These two items allow the user to set the gauges Time and Date if required.

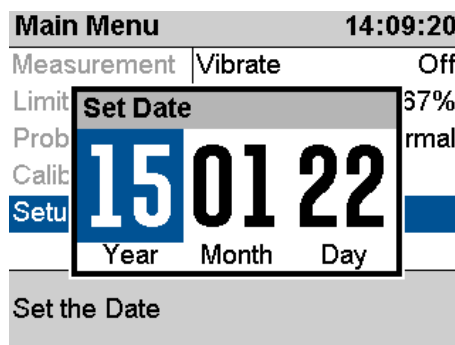
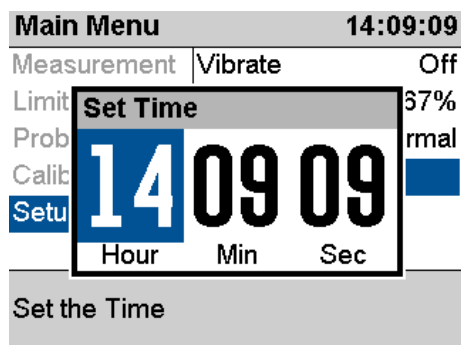

Set Time and Date Screens.

Note. Although the Cygnus 4 gauge displays the time and date it does not use them for any function.

8. General Points On Thickness Gauging

On very rough surfaces and especially if both sides are badly corroded, it is often necessary to move the Probe around to locate a back wall reflector. Sometimes a slight rocking movement can help find reflectors which are otherwise impossible.

Badly corroded sections can also be soaked with a light lubricating oil to improve ultrasound coupling through to the good material.

Always ensure that there is plenty of couplant present for good contact, but beware that on a pitted surface the Gauge may just measure the couplant-filled pit, always avoid measuring directly over external pits.

Beware that in extreme conditions or if the plate is of poor quality and contains many inclusions the ultrasound will be scattered to such an extent that measurement may not be possible.

Beware that the multiple-echo technique will not work if the front and back surfaces of the material being measured are not close to parallel. Also note that long narrow bars cannot be gauged along their length with the multiple-echo method.

The Gauge should not be used near arc-welding equipment, as this affects its performance.

9. Troubleshooting

The Gauge will not Switch On

- Are the batteries exhausted?
- Check the batteries are inserted correctly.

Difficulty obtaining a Reading

- Check that the Probe lead is properly connected to both Probe and Gauge.
- Check the gauge is set for the probe connected.
- Check the condition of the lead, replace if necessary.
- Check the Probe and its membrane are properly assembled (if a single element probe).
- On heavily corroded areas this is often a problem, try and take measurements in adjacent areas of the same material.
- Check the Gauge and Probe together on a test block, if there is still no reading the Gauge may require servicing.

If Readings are Erratic or Unstable

- Check that the Probe-lead is properly connected to both Probe and Gauge.
- Check that the Probe and its membrane are correctly assembled with sufficient couplant between the probe face and membrane.
- Check the Probe Type is suitable for the probable minimum thickness of the material being measured. Probe frequencies too low cause doubling and tripling of the actual thickness.

Tips for Optimising Battery Life

- Couplant left on the probe face will stop the gauge entering low power saving mode – so wipe couplant off the probe face between measurement sessions.
- Turning down the backlight brightness will extend battery life.
- Turn Bluetooth off if you are not using it.

- When measuring on very heavily corroded metal with single element probes the gauge uses more power searching for a multiple echo match – this can significantly reduce battery life. So if you are frequently measuring on very heavy corrosion consider using a twin element probe as this will require less power to get measurements.

10. Updating your Gauge

As part of our policy of ongoing development and product improvement Cygnus may issue firmware updates for your model of gauge. The firmware on the gauge can be easily updated by the user using update software downloaded from the Cygnus website.

Before updating your gauge note the model and serial number of the gauge (see Turning the Gauge On on page 19). You can then check on the Cygnus website if your gauge has the latest firmware version, and if not proceed to download the update software.

You can check for the latest gauge firmware on the Cygnus website [<http://www.cygnus-instruments.com>]. Navigate to **Support -> Downloads -> Technical Software** and look for a PDF document called 'M5 Surface Gauge Firmware Version Info' view this document to find the latest version for your gauge along with any changes made. *Note you will need to create an account to access this section of the website.*

Update Software

To update a gauge you must first download and install the 'Cygnus M5 Surface Gauge Updater' software. This is available from the Cygnus website in the **Support -> Downloads -> Technical Software** section. There is a PDF document with instructions available.

Gauge Firmware Files

You must download the appropriate Gauge Firmware file for the model of gauge, there are three to choose from; Cygnus 2/2+, Cygnus 4/4+ or Cygnus 6+ PRO.

Once downloaded the gauge can be easily updated via the USB cable connecting the gauge to the computer. The whole process takes about 2 minutes. There is a PDF document with detailed instructions available on the website.

11. Care and Servicing

Cleaning the Gauge

- ✓ Clean the Gauge and accessories with a damp cloth. Use water with a mild detergent household cleaner.
- ✗ Do not use solvents to clean the Gauge.
- ✗ Do not use any abrasive cleaner, especially on the display window.
- ✗ Do not immerse the Gauge in liquid when cleaning.

Batteries

- ✓ Always remove the batteries if the Gauge will not be used for more than a few days.
- ✓ Only use leak-proof batteries, Cygnus recommend Duracell batteries.

Environmental

- ✗ Do not immerse the Gauge in liquids. The gauge is designed to be IP67 but it is not intended for use in water.
- ✗ Do not subject the Gauge to temperatures greater than 50°C (122°F).
- ✗ Do not store the Gauge for long periods in conditions of high humidity.

Repairs

- ✗ There are no user serviceable parts inside the Gauge. Therefore all repair work should be carried out by Cygnus Instruments or by an Authorised Cygnus Service dealer.

Returning the Gauge for Servicing

A full Manufacturer's Factory Service is available from Cygnus Instruments.



The Complete Kit should always be returned for Service or Repair, including all Probes and Leads.

Cygnus Gauges are renowned for their reliability, very often problems with getting measurements are simply due to the way the Gauge is being used.

However, if you do need to return your Gauge for Repair please let us know the details of the problem, to help us guarantee the best possible service:

- Is the problem Intermittent Behaviour?
- Is there a problem turning the Gauge On?
Or a problem with the Gauge turning itself Off?
- Does the Gauge constantly give Incorrect Readings, or Unsteady Readings?
- Is it not possible to Calibrate the Gauge?

12. Information

Technical Specifications

Cygnus M5-C4 Technical Specifications			
General Attributes			
Size	84 mm x 130 mm x 35 mm (W x H x D) (3.3 in x 5.1 in x 1.4 in)		
Weight	Gauge with batteries 300 g (10.5 oz.)		
Power Supply	3 x AA / R6 Batteries.		
Probe Socket	1 x Lemo 1S		
Operating Temperature Range	-10°C to +50°C (14°F to 122°F)		
Storage Temperature Range	-10°C to +60°C (14°F to 140°F)		
Battery Operation Time	Approximately 10 hrs. continuous measurement with fully charged Duracell Alkaline LR6 batteries.		
Battery Voltage Range	Min 3.0 V dc, Max 4.5 V dc		
Battery Type	AA Size. LR6 Alkaline / HR6 NiMH.		
Low Battery Indication	Battery level indication on display with low battery warning message.		
PRF	N/A		
Monitor Outputs	N/A		
Through Coating Measurements	Multiple-Echo mode with Single element 0° probe; <ul style="list-style-type: none"> Through coating measurement for coatings up to 3 mm thick as standard depending on coating velocity with S2C probe. Deep Coat mode provides ability to measure through thicker coatings depending on coating material with S2C probe. 		
Materials	Sound velocity from 1000 m/s to 9000 m/s [0.0390 in/us to 0.3543 in/us]		
Measurement Ranges	Measurement ranges in steel.		
	Single element 0° probes in Multiple Echo mode;		
	S2C probe	3 to 250 mm	[0.120 in. to 10.00 in.]
	S3C probe	2 to 150 mm	[0.080 in. to 6.000 in.]
	S5C/A probes	1 to 50 mm	[0.040 in. to 2.000 in.]
Probe Zero	Single element probes in multiple echo mode do not need to be zeroed.		
Measurement Modes	Multiple Echo using Single element probe. Uses three matched and verified back-wall echoes to determine the material thickness and ignore surface coatings.		
High Temperature	All standard single element and twin element probes:		

Cygnus M5-C4 Technical Specifications			
Measurement	Allows continuous measurement up to 75°C (160°F).		
Resolution	Multiple Echo measurement modes;		
	Low (measurement > 120 mm)	0.1 mm	[0.005"]
	Medium (measurement < 120 mm)	0.05 mm	[0.002"]
Accuracy	±0.05 mm (±0.002") - in Multiple-Echo measurement mode, when calibrated and measuring the same material as calibrated on.		
Display			
Type of Display	Colour TFT LCD with LED Backlight		
Display Size	240 x 128 Pixels QVGA. 2.4", 47 mm (W) x 37 mm (H)		
Display Information	Digital Thickness Value. Settings. Battery Level.		
Transmitter			
Shape of Pulse	Square		
Pulse Energy : Voltage (peak-to-peak)	70 V p-p		
Pulse Energy : Rise Time	3 ns (max)		
Pulse Energy : Pulse Duration	S2C : 220 ns S3C : 100 ns S5A / S5C : 67ns		
Receiver			
Gain Control	Automatic Gain Control depending on probe and measurement mode.		
Frequency Range	1.0 MHz to 10.0 MHz (-6dB)		
Other Information			
Data Output and Storage	Non.		
Data Connector	USB Mini B Connector under battery cover.		
Calibration setting storage	Calibration Data stored to Internal Flash Memory		
Calibration Mechanisms	Single Point calibration of velocity of sound in Multiple Echo mode.		
Display & Recall Facilities	N/A		
Display Response Time	125 ms / 500 ms		
Printer Output	N/A		
Environmental Rating	IP67 (Water immersion 1 metre depth for 30 minutes) MIL STD 810G Method 501.6 (High Temp +55°C) MIL STD 810G Method 502.6 (Low temp -20°C) MIL STD 810G Method 507.6 (Humidity 95%) MIL STD 810G Method 512.6 (Immersion 1m, 30min)		
Shock & Impact	MIL STD 810G Method 514.7 (Vibration) MIL STD 810G Method 516.7 (Shock 20g) MIL STD 810G Method 516.7 (Transit Drop 1.22m)		

Cygnus M5-C4 Technical Specifications

Compliance	CE, UKCA, RoHS
Designed for	BS EN 15317

Specifications are subject to change for product improvement.

Table of Sound Velocities

Velocities will vary according to the precise grade and processing conditions of the material being measured.

 This table is included as a guide only.
Wherever possible, the Gauge should always be calibrated on the material under test.

 These Velocities are given in good faith and are believed to be accurate within the limits described above.
No liability is accepted for errors.

Velocities given are the compressional wave velocity c_l .

Material	Velocity of Sound (V)		Conversion Factor (f)
	m/s	in/us	
Aluminium (alloyed)	6380	0.2512	1.078
Aluminium (2014)	6320	0.2488	1.068
Aluminium (2024 T4)	6370	0.2508	1.076
Aluminium (2117 T4)	6500	0.2559	1.098
Brass (CuZn40)	4400	0.1732	0.743
Brass (Naval)	4330	0.1705	0.731
Brass (CuZn30)	4700	0.1850	0.794
Copper	4700 - 5000	0.1850 - 0.1969	0.794 - 0.845
Core Ten	5920	0.2331	1.000
Grey Cast Iron	4600	0.1811	0.777
Inconel	5700	0.2244	0.963
Lead	2150	0.0846	0.363
Monel	5400	0.2126	0.912
Nickel	5630	0.2217	0.951
Phosphor Bronze	3530	0.1390	0.596
Mild Steel	5920	0.2331	1.000
Tool Steel	5870	0.2311	0.992
Stainless Steel 302	5660	0.2228	0.956
Stainless Steel 347	5790	0.2279	0.978

Stainless Steel 304	5664	0.2229	0.956
Stainless Steel 314	5715	0.2250	0.965
Stainless Steel 316	5750	0.1163	0.971
Tin	3320	0.1307	0.561
Titanium	6100 - 6230	0.2402 - 0.2453	1.030 - 1.052
Tungsten Carbide	6660	0.2622	1.125

Reading Conversions

If only a few measurements are to be taken on a material other than Steel, it may be easier to leave the calibration set for Steel and merely convert the readings by multiplying by the **Conversion Factor** for the material being measured.

This method avoids unnecessary recalibration.

Example.

The Gauge is calibrated for Steel [5920 m/s], but the reading is being taken on Copper [4700 m/s] :

$$\begin{aligned}
 T &= t \times V_{\text{COPPER}} / V_{\text{STEEL}} \\
 &= t \times 4700 / 5920 \\
 &= \underline{t \times 0.794}
 \end{aligned}$$

thus : **T = t x f** [where: f = $V_{\text{COPPER}} / V_{\text{STEEL}}$]

where : **T = true thickness of Copper being measured**

t = actual reading obtained

f = Conversion Factor (from table)

V_{COPPER} = Sound Velocity in Copper : 4700 m/s

V_{STEEL} = Sound Velocity in Steel : 5920 m/s

The **Conversion Factor f**: is given for various materials in the Table of Sound Velocities

13. Recycling and Disposal (EC Countries)

The WEEE Directive (Waste Electrical and Electronic Equipment 2002/96.EC) has been put into place to ensure that products are recycled using best available treatment, recovery and recycling techniques to ensure human health and high environmental protection.

The Gauge has been designed and manufactured with high quality materials and components which can be recycled and reused. It may contain hazardous substances that could impact health and the environment. In order to avoid the dissemination of those substances in our environment and to diminish the pressure on natural resources we encourage you to dispose of this product correctly.



DO NOT dispose of this product with general household waste.

DO dispose of the complete product including cables, plugs and accessories in the designed WEEE collection facilities.

This product may also be returned to the agent or manufacturer who supplied it for safe end-of-life disposal.

Cygnus Instruments Ltd registration number for The WEEE Directive is WEE/HE1274RU.

14. Warranty Information

LIMITED THREE YEAR WARRANTY FOR CYGNUS ULTRASONIC THICKNESS GAUGES

1. Cygnus Instruments Limited ("CYGNUS") warrants that, subject as set out below, the Products manufactured by it (excluding consumables, batteries, probes, leads, microphones and telescopic extensions) will be free from defects in materials and workmanship for a period of three years from the date of purchase either from CYGNUS or from an Authorised CYGNUS Distributor. Batteries, probes, leads, microphones and telescopic extensions are warranted for 6 months. This warranty is limited to the original Purchaser of the Product and is not transferable. During the warranty period, CYGNUS will repair, replace or refund, at its option, any defective Products at no additional charge, provided that the product is returned by the original Purchaser, shipping prepaid, to CYGNUS or an Authorised CYGNUS Distributor. If shipped by mail or any common carrier, the Purchaser must insure and accept all liability for loss or damage to the Product and must use shipping containers equivalent to the original packaging. Replacement products or parts will be furnished on an exchange basis only. All replaced products or parts become the property of CYGNUS.
2. Any defects in materials or workmanship must be notified to CYGNUS by the Purchaser within seven days after the discovery of the defect or failure.
3. Dated proof of purchase must be provided by the Purchaser when requesting warranty work to be performed or making any other claim under this warranty. CYGNUS will not be liable under this warranty unless the total price for the Product was paid by the due date for payment.
4. This warranty does not extend to any products which have been damaged as a result of, accident, misuse or abuse, natural or personal disaster, service, modification or repair by anyone other than CYGNUS or an Authorised CYGNUS Service Centre, failure to properly store or maintain the Product, negligence, abnormal working conditions, fair wear and tear, or failure to follow the instructions issued by CYGNUS in relation to the Product.
5. Except as expressly set forth above or in the CYGNUS Terms of Sale, subject to which the Products were purchased, all warranties, conditions or other terms implied by Statute or Common Law are extended to the fullest extent permitted by law.
6. Except in respect of death or personal injury caused by the negligence of Cygnus, Cygnus shall not be liable to the Purchaser or to any other person by reason of any representation (unless fraudulent), or any implied warranty, condition or other term, or any duty at common law, or under the express terms of the contract for purchase of the Products, for loss of profit or for any indirect, special or consequential loss or damage, costs, expenses or other claims for compensation whatsoever (whether caused by the negligence of Cygnus, its employees or agents or otherwise) which arise out of or in connection with the supply of the Products or their use or resale by the Purchaser or by any other person. The entire liability of Cygnus under or in connection with the Products shall not exceed the price paid for the Products, except as expressly provided in this warranty.

15. Index

- Automatic Power Off, 19
- Batteries
 - Fitting, 8
 - Level, 24
 - Life, 23
 - Low Battery Warning, 24
 - NiCad, 8
 - NiMH, 8
- BS EN 15317:2007, 26
- Calibration
 - Conversion Factor, 55
 - Known Thickness, 26
 - Single Point, 26
 - Velocity of Sound, 28
- Deep Coat, 39
- Disposal, 56
- Gauge
 - Cleaning, 49
 - Display, 18
 - Keys, 18
 - Serial Number, 19
- Ignore Coatings, 12
- Imperial, 35
- Main Menu, 30
- Measurement
 - Pitted surface, 45
- Measurement
 - Resolution, 35
 - Rough surfaces, 45
 - Units, 35
- Metric, 35
- Multiple Echo, 12
 - Echo Bars, 21
- Neck Strap, 9
- Power button, 19
- Probes
 - Automatic Detection, 34
 - Cable, 9
 - Connector, 18
 - Knurled Ring, 15
 - Membrane Couplant, 15
 - Membrane Key, 15
 - Polyurethane Membrane Membrane, 13
 - Type, setting, 33
- Recycling, 56
- Repair, 50
- Resolution, 35
- Service, 50
- Sound Velocities, 54
- Test block, 26
- Thick Coatings, 39
- Thickness Measurement, 21
- Troubleshooting, 46
- Units, 35
- Warranty, 57
- WEEE Directive, 56