

# **Cygnus 4**

## **Operating & Accessories Manual**

**Doc No. M4-CYG4-M-ENG\_Iss7.doc**  
16 April 2013  
(Mk4 Cygnus 4 Gauges)

## QUALITY POLICY STATEMENT

*“Cygnus Instruments is committed to being a premier supplier of niche test and measurement instruments. Cygnus is dedicated to customer satisfaction. Cygnus will always provide products and service of exceptionally high quality. We will listen to our customers and be both market-led and technology driven. And by utilising a formal Operations Management System that complies with industry standards, we will continually improve what we do and how we do it.”*

Cygnus is an ISO-9001 accredited company.  
The scope of our accreditation covers all our products and services.



## Contents

<b>1. Introduction.....</b>	<b>5</b>
Cygnus 4 Thickness Gauge .....	5
Multiple Echo Measurements .....	6
Triple Echo Verification.....	6
Cygnus Instruments .....	7
<b>2. Gauge Kit Contents .....</b>	<b>8</b>
<b>3. Gauge Preparation .....</b>	<b>9</b>
Fitting the Batteries.....	9
Connecting the Probe.....	10
Fitting the Protective Sleeve .....	11
Fitting the Neck Strap .....	12
Optional Krusell Belt Attachment .....	12
<b>4. Gauge Operation .....</b>	<b>13</b>
Gauge Controls .....	13
Display and Automatic Backlight.....	14
Gauge Key Functions .....	14
Turning the Gauge On.....	15
Turning the Gauge Off .....	15
Automatic Power Off .....	15
Taking a Thickness Measurement .....	16
Echo-Strength Indicators.....	17
Coupling Strength Indicator .....	18
Battery Life .....	19
Battery Life Gauge.....	19
Low Battery Warning .....	20
<b>5. Probes &amp; Membranes .....</b>	<b>21</b>
Probe Selection.....	21
Changing the Membrane .....	22
Probe Selection & Specifications .....	23
Probe Frequency Identification .....	23
<b>6. Gauge Setup .....</b>	<b>24</b>
Gauge Menu Diagram .....	24
Calibrating the Gauge .....	24
Calibrating to a known thickness (Single Point).....	26
Setting the Velocity of Sound .....	27
Measurement Units.....	29

Resolution Setting .....	30
Minimum Thickness Alarm Function. ....	31
Deep Coat Function .....	33
Deep Coat Warning Message .....	34
Valid Thickness 'Beep' Function .....	35
Automatic Probe Frequency Setting .....	36
<b>7. General Points On Thickness Gauging .....</b>	<b>37</b>
<b>8. Troubleshooting .....</b>	<b>38</b>
The Gauge will not Switch On .....	38
Difficulty obtaining a Reading.....	38
If Readings are Erratic or Unstable .....	38
<b>9. The 4 Point Check .....</b>	<b>39</b>
<b>10. Care and Servicing .....</b>	<b>40</b>
Cleaning the Gauge .....	40
Batteries .....	40
Environmental .....	40
Repairs .....	40
Returning the Gauge for Servicing .....	41
<b>11. Information .....</b>	<b>42</b>
Technical Specifications.....	42
Table of Sound Velocities .....	44
Reading Conversions.....	45
<b>12. Accessories List .....</b>	<b>46</b>
Remote Probes with 1.35m (4'6") Lead .....	46
Marinised Probes with Cable Length to Order .....	47
Probe Spares and Membranes .....	48
Cables and Leads .....	49
Miscellaneous Spares .....	49
Carry Cases.....	49
<b>13. EU Declaration of Conformity.....</b>	<b>50</b>
<b>14. Recycling and Disposal (EC Countries).....</b>	<b>51</b>
<b>15. Index .....</b>	<b>52</b>

# 1. Introduction

## Cygnus 4 Thickness Gauge

The **Cygnus 4 Multiple-Echo Ultrasonic Thickness Gauge** is a rugged, handheld, battery-powered instrument designed for high-reliability thickness measurement using the multiple-echo technique.

The Gauge can be used with a choice of single-crystal Ultrasonic Probes, depending on the thickness and type of material which is to be measured.

Measurements can be displayed in Metric (mm) or in Imperial (inch) units and measurement resolution can be selected for either 0.1 or 0.05 mm, (0.005 inch or 0.002 inch). The Gauge has a large LCD which can be easily read in sunlight and in low-light situations using a white LED backlight.

Crystal-controlled Calibration provides stability and accuracy. The gauge can easily be calibrated to a known thickness or to a known Velocity of Sound. Velocity of Sound is displayed in either m/s or in/ $\mu$ s, depending on the current selection for Measurement Units.

The Gauge is able to operate accurately in a wide range of ambient temperatures and is environmentally sealed to IP65 & IP67 for use in wet or dusty conditions.



The Gauge is a solid-state electronic instrument which, under normal operating conditions, will give many years of active service.

Although designed for ease of operation the first time user should carefully read this manual to familiarise themselves with the features of the Gauge.

## Multiple Echo Measurements

The Gauge works on the pulse-echo principle. The Probe transmits a very short pulse of ultrasound which enters the test piece. The Probe then acts as a receiver listening for return echoes, converting them into electrical signals which are processed to produce timing information that can be used to determine the material thickness.

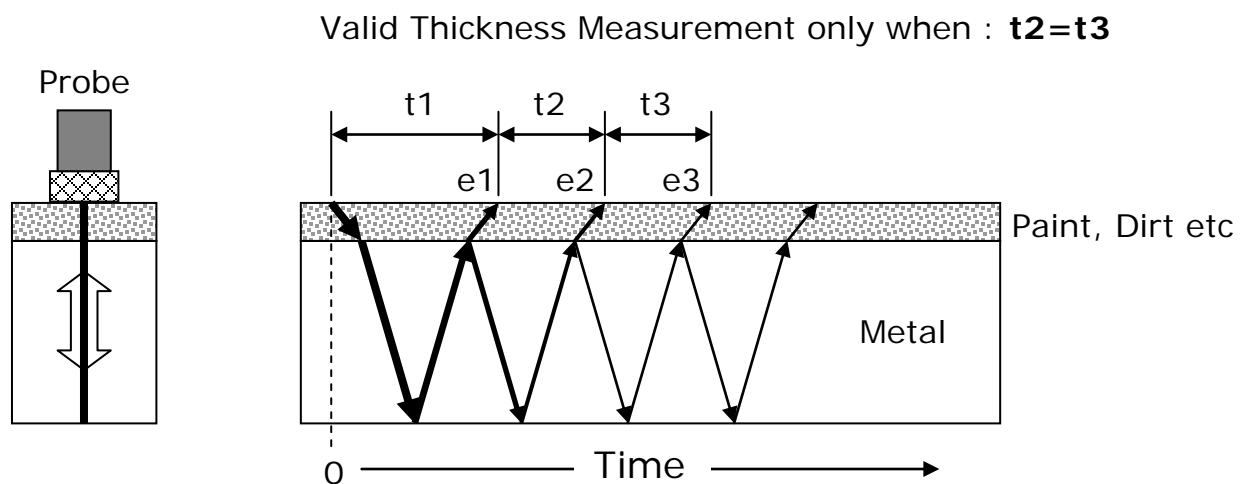

The *multiple-echo* beam travel is depicted above, spread out in time, to illustrate the timing method. In reality the beam path is straight and perpendicular to the surface as the ultrasonic energy reverberates up and down within the metal (shown on the left). Each time an echo is reflected back down, a small portion of the energy comes up through the coatings and is detected by the Probe which acts as a receiver ( $e_1$ ,  $e_2$  and  $e_3$ ).

The delay between echoes at the Probe-face ( $t_2$  and  $t_3$ ) is exactly equal to the time taken to pass through the metal twice, therefore coatings such as paint are ignored and the measurement displayed is the metal thickness only.

### Triple Echo Verification

The Gauge requires 3 equi-spaced return echoes in order to calculate a thickness measurement value ( $t_2 = t_3$ ). This method ensures the Gauge only displays valid thickness values, the three echoes provide a reliable method of signal verification. This process is referred to as Triple Echo Verification.

## Cygnus Instruments

*Cygnus Instruments Limited*, founded in 1983, was the pioneer in the development of the *Digital Ultrasonic Multiple-Echo Technique* used for measurement through coatings. This has long been the industry standard to ensure that accurate measurements are taken without the need to zero the Gauge nor to remove any coatings.

Our philosophy is to work closely with our customers to provide high quality products, engineered to serve heavy industry & harsh environments. Cygnus Ultrasonic thickness gauges are designed to be reliable and simple to use. We have an unrivalled reputation in over 45 countries around the world.



### **CYGNUS Instruments Ltd.**

Cygnus House, 30 Prince of Wales Road,  
Dorchester, Dorset DT1 1PW England.

Tel: 00 44 (0) 1305 265533

[www.cygnus-instruments.com](http://www.cygnus-instruments.com)

Fax: 00 44 (0) 1305 269960

[sales@cygnus-instruments.com](mailto:sales@cygnus-instruments.com)

#### **CYGNUS Instruments Inc.**

1993 Moreland Parkway, Suite 202.  
Annapolis, Maryland 21401, USA.

Tel: +1 410 267 9771

Fax: +1 410 268 2013

[www.cygnusinstruments.com](http://www.cygnusinstruments.com)

[sales@cygnusinstruments.com](mailto:sales@cygnusinstruments.com)

#### **CYGNUS Singapore (S) Pte. Ltd.**

63 Jalan Pemimpin #05-01,  
Pemimpin Industrial Building.  
577219 Singapore.

Tel : +65 6252 5909

Fax : +65 6251 1318

[www.cygnus-instruments.sg](http://www.cygnus-instruments.sg)

[sales@cygnus-instruments.sg](mailto:sales@cygnus-instruments.sg)

## 2. Gauge Kit Contents

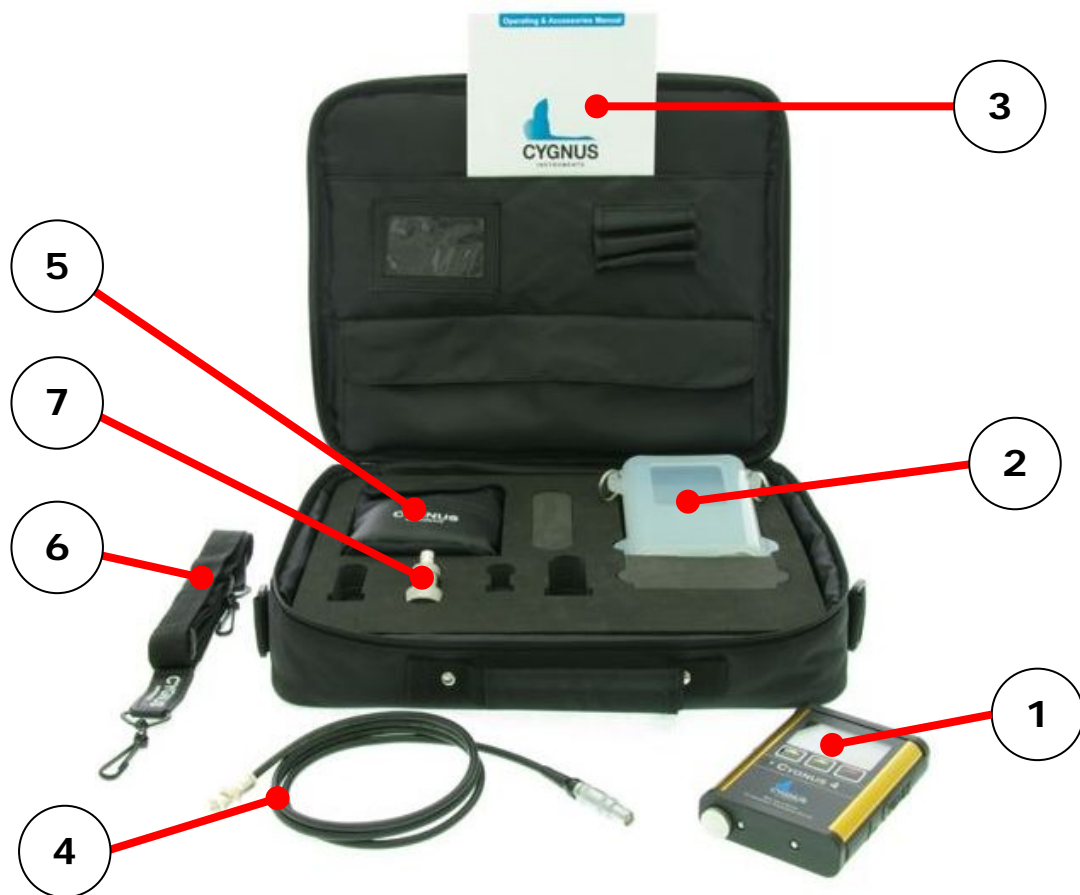

1. Cygnus 4 Gauge
2. Protective Silicone Sleeve
3. Cygnus 4 Operation Manual
4. Blue High Flex Probe Cable, 1.5 m (4½ ft) \*
5. Accessory Pouch, containing Couplant Gel, Spare Membranes, Membrane Couplant, Membrane Locking Ring Key, 13 mm (or 1/2 inch) Test block and 2 x AA Procell Batteries
6. Adjustable Neck Strap \*
7. Probe(s)

\* The adjustable neck strap and probe cable will be stored in either the inside or outside pockets.



### 3. Gauge Preparation

The Gauge is supplied ready to use out of the box. Just insert the batteries, connect the probe to the Gauge, turn on the power and you are ready to take thickness measurements.

#### Fitting the Batteries

The Gauge requires 2 x AA/LR6/UM3 Batteries. Cygnus supplies and recommends Duracell Procell Alkaline batteries.

The batteries are located behind a cover at the bottom of the Gauge. Unscrew this cover to replace the batteries. The batteries are inserted '+' or 'pip' first.

- ⚠ When refitting the battery cover screw ensure it is done up tightly by hand only. A drop of membrane-oil on the threads will help to ensure smooth operation and a good seal.

The Gauge is protected against damage from incorrect battery insertion.

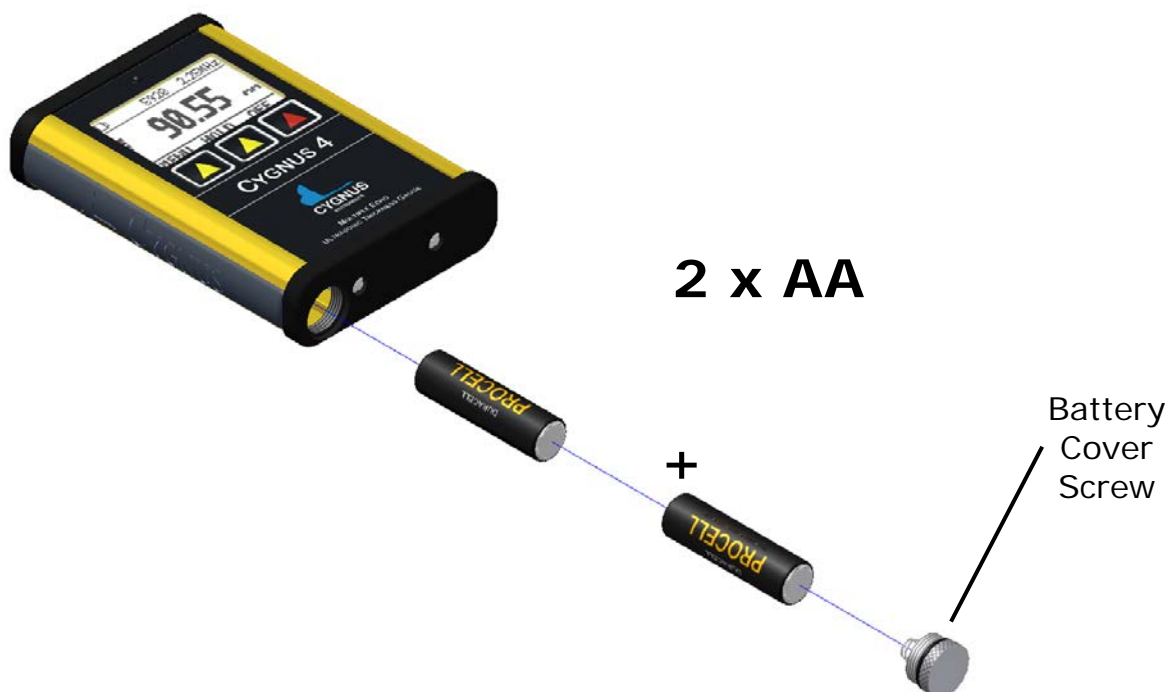

- ⚠ The Gauge can be fitted with NiCad or NiMH rechargeable batteries but this may reduce the specified operating time.

## Connecting the Probe

The Probe is connected to the Gauge with the supplied Probe Cable as shown below.

The Lemo 1 connector is removed by pulling back on its body.



## Fitting the Protective Sleeve

The Gauge is supplied with a protective Silicone Sleeve that fits over the Gauge. This sleeve is designed to protect the Gauge against bumps, scratches and dirt while in use whilst still allowing Gauge operation and battery replacement.

To insert the Gauge simply push the Gauge down into the sleeve, a lip at the top of the sleeve will retain the Gauge once fully inserted.

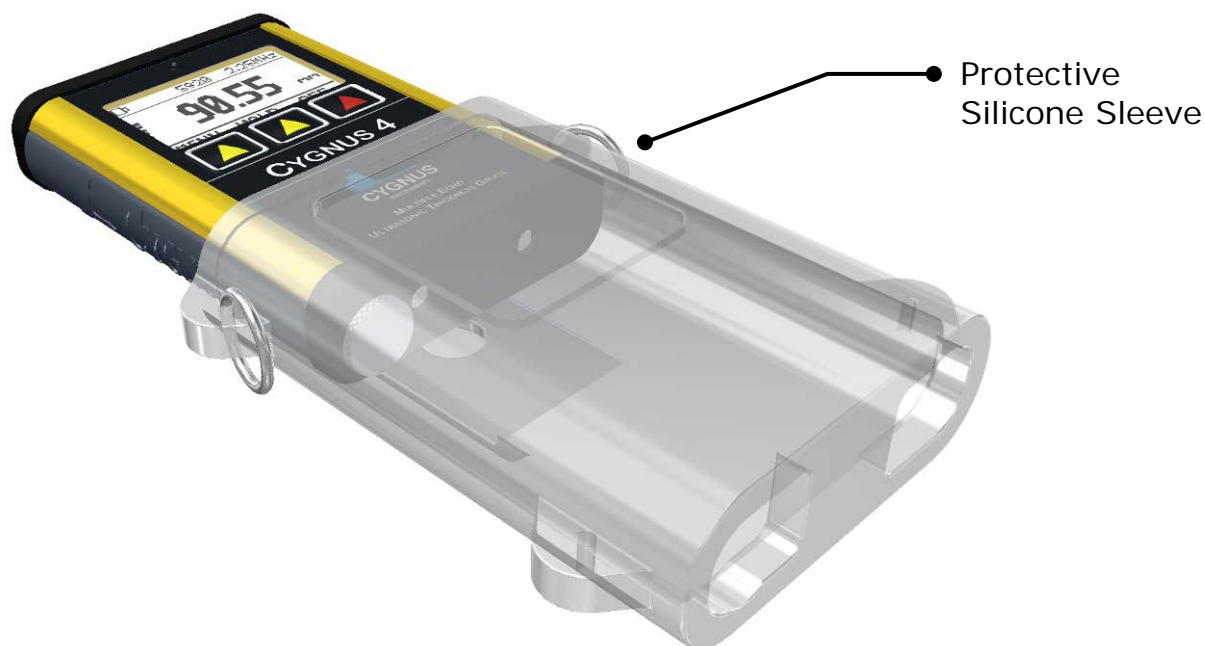

The Gauge is removed by pushing it out from the bottom.

The sleeve also allows the Gauge to be worn on a belt or suspended from the Neck Strap included in the kit.

### Fitting the Neck Strap

The Gauge is supplied with an adjustable Neck Strap. The ends of the neck strap clip onto rings at the top of the protective silicone sleeve.

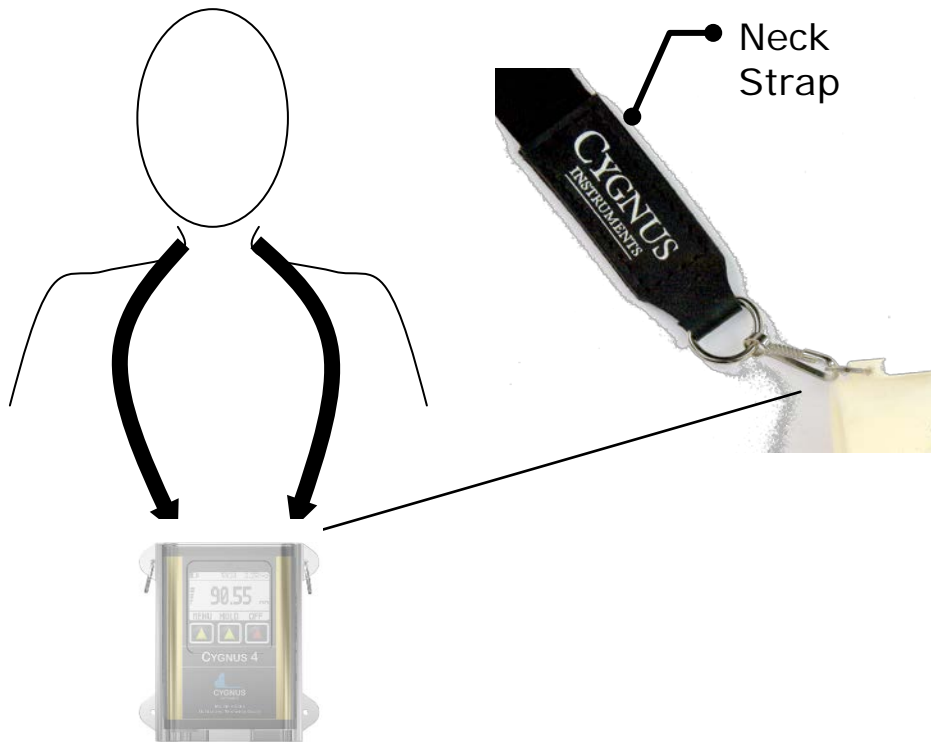

### Optional Krusell Belt Attachment

For attaching the silicone sleeve to a belt or harness we offer an optional Krusell® belt clip. The belt clip is attached to the protective silicone sleeve as shown below. This enables the gauge to be easily taken on and off the belt clip.

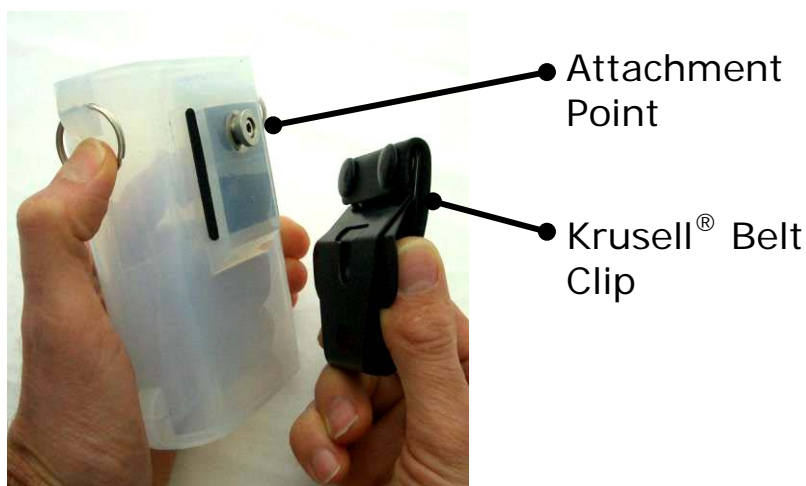

## 4. Gauge Operation

### Gauge Controls

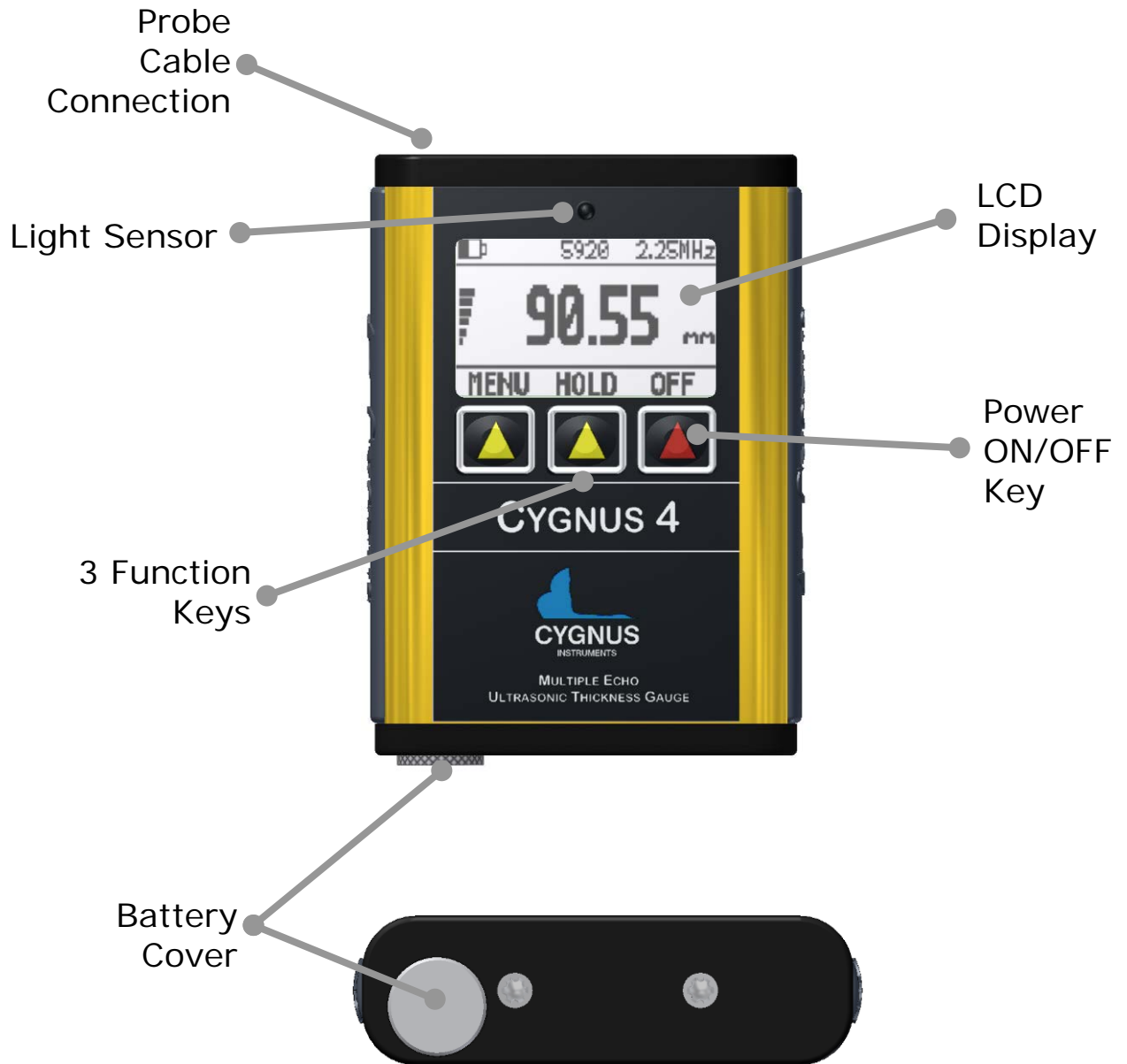

## Display and Automatic Backlight

The gauge uses a monochrome graphic LCD with 128 x 64 pixel resolution. The LCD is can be viewed in bright sunlight, and in low light conditions as white-LED backlight is provided.

The LCD backlight is turned on automatically when the light level drops below a pre-set level. The backlight uses white-LED technology and therefore does not draw significant current from the batteries when turned on.

## Gauge Key Functions

The gauge has three keys under the LCD screen with an upward pointing triangle. The function of each key corresponds to the word or symbol above it on the screen.

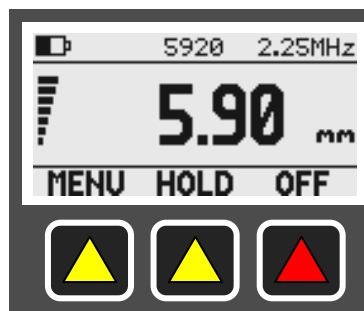



In the measuring screen the three keys are used for:

MENU	HOLD	OFF
Pressing this key displays the gauge Menu.	Pressing this key holds the displayed thickness measurement on the screen.	Pressing this key turns off the gauge if the key is then held for 1 second.

When in the menu and other screens the function of these three keys change. The word or symbol displayed above the key on the screen denotes the key's function.

The right hand key has a red triangle to show it is used to turn On or Off the gauge.

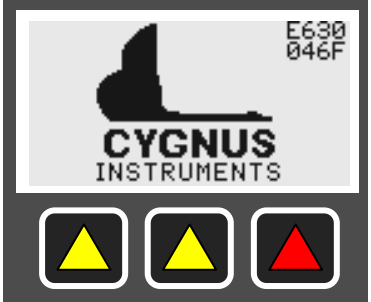
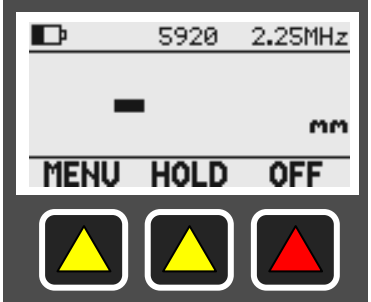
### Turning the Gauge On

<p><b>1.</b></p>	<p>Press the Power key (red Triangle key)</p>	
<p><b>2.</b></p>	<p>The display will show the Cygnus Instruments logo for about 3 seconds while the gauge initialises.</p>	
<p><b>3.</b></p>	<p>The measurement screen will then be displayed.</p>	
<p><b>4.</b></p>	<p>The Gauge is ready to use.</p>	

### Turning the Gauge Off

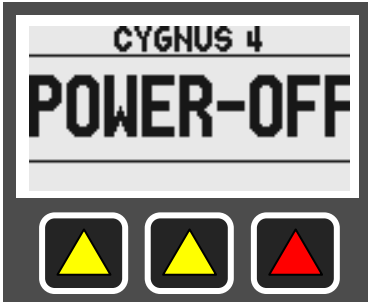
<p><b>1.</b></p>	<p>Press &amp; Hold the Power button for 1 second.</p>	
<p><b>2.</b></p>	<p>The display shows 'POWER OFF' then the Gauge turns off.</p>	

### Automatic Power Off

The Gauge will turn off automatically 5 minutes after the last thickness measurement was taken.

## Taking a Thickness Measurement

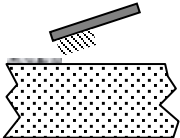
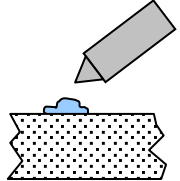
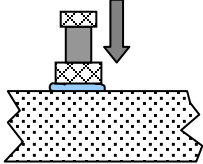
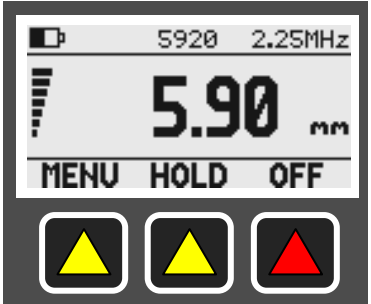
<p><b>1.</b></p>	<p>Remove all scale, rust, dirt or loose coatings and brush the test area clean.</p>	
<p><b>2.</b></p>	<p>Apply couplant to the test surface.</p>	
<p><b>3.</b></p>	<p>Place the probe-face on the clean, lubricated test surface and make firm contact applying gentle pressure.</p>	
<p><b>4.</b></p>	<p>The Gauge will display a thickness measurement or an indication of Echo Strength if no valid measurement has been found (See page 17).</p>	



## Echo-Strength Indicators

Should the Gauge be unable to detect a stable multiple-echo signal it displays an Echo Strength indication to help the operator locate a suitable position.

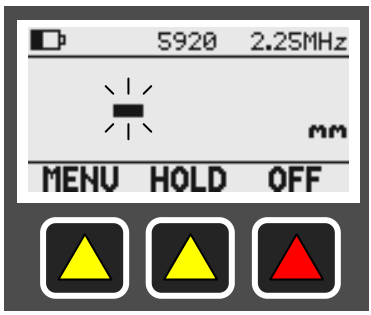
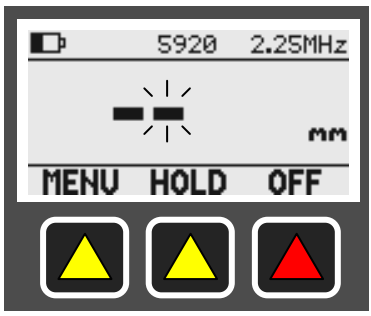
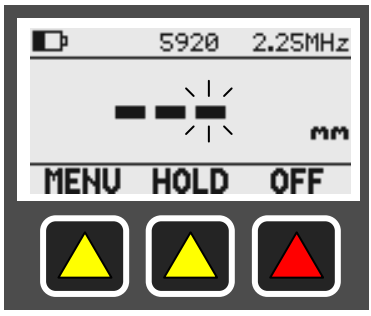
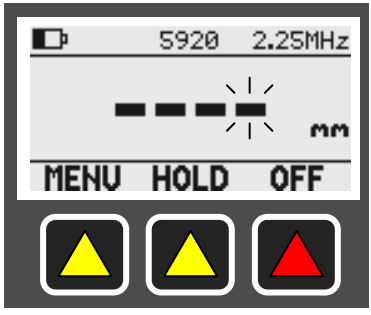
<p><b>1.</b></p>	<p>1 Bar Flashing: No echoes detected.</p>	
<p><b>2.</b></p>	<p>1 steady + 1 Bar Flashing: Only 1 echo detected.</p>	
<p><b>3.</b></p>	<p>2 steady + 1 Bar Flashing: Only 2 echoes detected.</p>	
<p><b>4.</b></p>	<p>3 steady + 1 Bar Flashing: 3 echoes detected but they are not related.</p>	

To help obtain a multiple echo reading the operator should continue to move the probe around to locate a suitable reflector, using a slight rocking motion.

## Coupling Strength Indicator

When the gauge displays a valid thickness measurement there is a vertical coupling strength indicator displayed on the left side of the screen. This shows the strength of the return echo signal giving the user an idea of

- a) How well the probe is coupled to the test material.
- b) How attenuative is the material and coating.

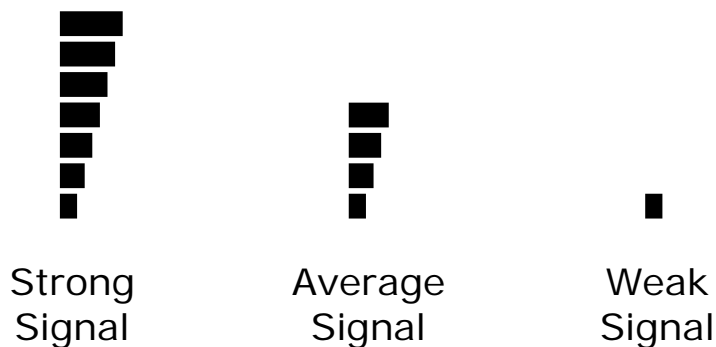

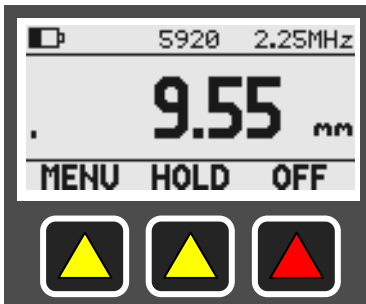
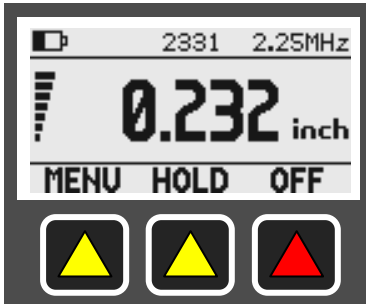
1.	This coupling strength indicator shows a <b>weak</b> signal is being received.	
2.	This coupling strength indicator shows a <b>strong</b> signal is being received.	

## Battery Life

The Gauge will operate continuously for approximately 30 hrs when fitted with Duracell Procell Alkaline 1500 mA/hr batteries.

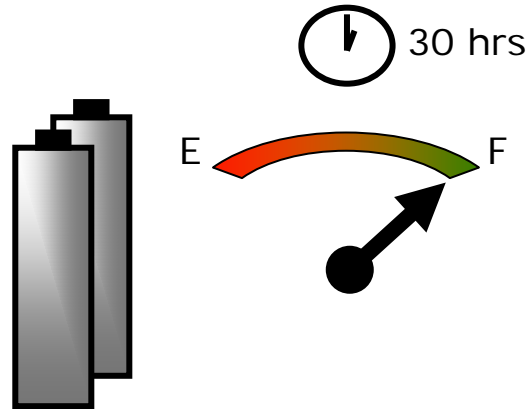

## Battery Life Gauge

The battery level is displayed on the measuring screen at the top left of the screen.

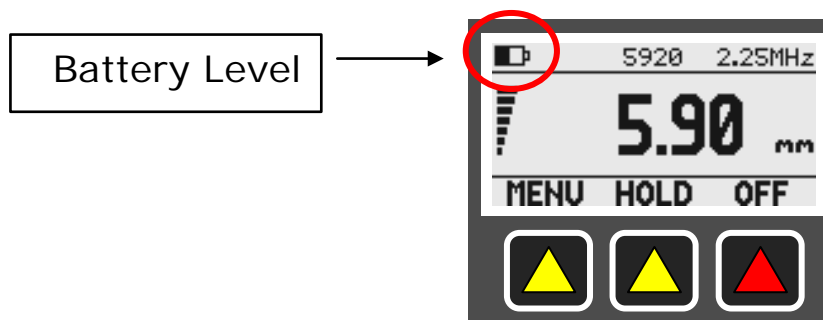

New Battery – Full.



Half Used battery.



Almost Flat battery.

## Low Battery Warning

The gauge will flash a Low Battery warning message at the top of the screen when the battery level is below 15% capacity. This means you have between 1 to 2 hours of gauge operation time remaining.

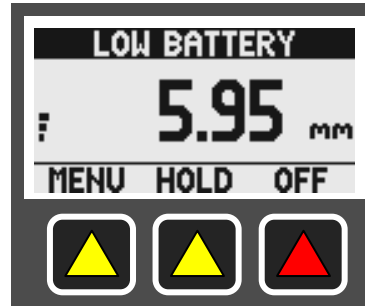

Low Battery warning message.

## 5. Probes & Membranes

 The Gauge should only be used with Soft-Faced probes supplied by Cygnus Instruments.

Cygnus Soft-Faced probes are fitted with a Polyurethane Membrane which provides better contact on rough surfaces and protects the probe face from wear, prolonging the life of the probe.

Check the membrane regularly as it is important the membrane is changed as soon as it shows any signs of wear.

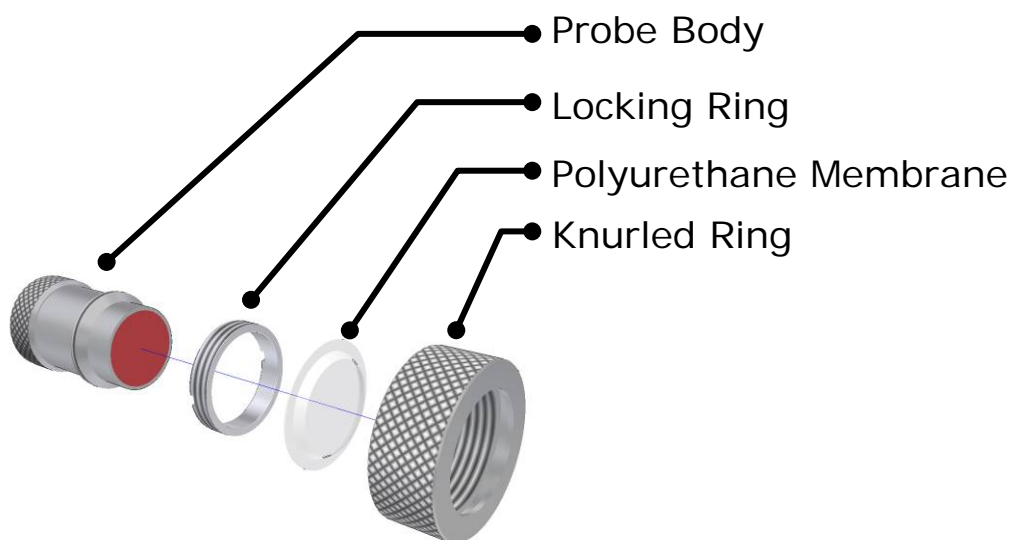





### Probe Selection

Apart from the physical limitation of the probe size, the diameter of the probe face (crystal) and the frequency affect the probe performance, generally:

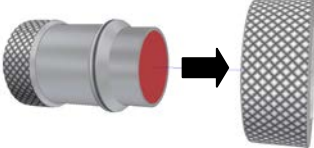
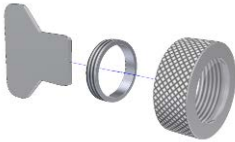
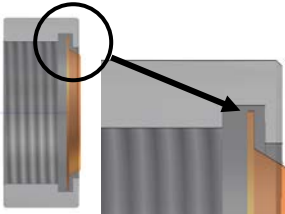
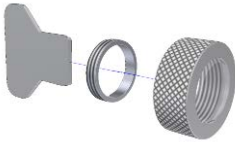
- Large diameter probes produce more energy which gives better performance on heavily corroded materials.
- Higher Frequency probes produce a narrower focused beam which is better when looking for small features or on thin materials.

## Changing the Membrane

<p><b>1.</b></p>	<p>Unscrew the Knurled Ring from the end of the Probe</p>	
<p><b>2.</b></p>	<p>Use the Locking Ring Key to unscrew the Locking Ring from inside the Knurled Ring. The old membrane can then be removed and discarded.</p>	
<p><b>3.</b></p>	<p>Place a new membrane into the end of the Knurled Ring ensuring it locates in the groove.</p>	
<p><b>4.</b></p>	<p>Screw the Locking Ring back inside the Knurled Ring and tighten with the Locking Ring Key.</p>	
<p><b>5.</b></p>	<p>Place a few drops of Membrane Couplant on to the probe face.</p>	
<p><b>6.</b></p>	<p>Screw the Knurled Ring back onto the probe. Use your thumb to squeeze the couplant from under the membrane as you tighten the Knurled Ring down</p>	
<p><b>7.</b></p>	<p>You should see the membrane has a very thin film of couplant between itself and the probe face with <u>no air bubbles</u>.</p>	

## Probe Selection & Specifications



Crystal Diameter	Frequency	Measurement Range	Application
13 mm ½ inch	2¼ MHz	3.0 – 250 mm <sup>1</sup> 0.12 – 10 inch	<b>This is the standard probe – suitable for most applications.</b>
13 mm ½ inch	3½ MHz	2.0 – 150 mm 0.08 – 6 inch	Suitable for measurement on thinner sections where surfaces are relatively rough
6 mm ¼ inch	5 MHz	1.0 – 50 mm 0.04 – 2 inch	The higher frequency and narrower beam makes this Probe ideal for measuring small-bore tubing, thin section plate and other areas where access is limited.
13 mm ½ inch	5 MHz	1.0 – 50 mm 0.04 – 2 inch	Ideal for thin sections without heavy corrosion.

**Lower frequency probes offer better penetration on heavy corrosion/coatings.**

## Probe Frequency Identification

The frequency of Cygnus probes is indicated by colour;

<b>Red = 2.25 MHz</b>	<b>Orange = 3.5 MHz</b>	<b>Black = 5.0 MHz</b>
-----------------------	-------------------------	------------------------

Old Style Probes	Inox Probes with BNC Connectors	Inox Remote Probes
Coloured Probe Face	Coloured Ring under BNC connector	Coloured Band on Probe Cap
		

<sup>1</sup> To measure thicknesses on tall thin cylinders or columns the height-width ratio should be no less than 1.0:0.6 (Height: Width) otherwise side reflections prevent measurement.

## 6. Gauge Setup

### Gauge Menu Diagram

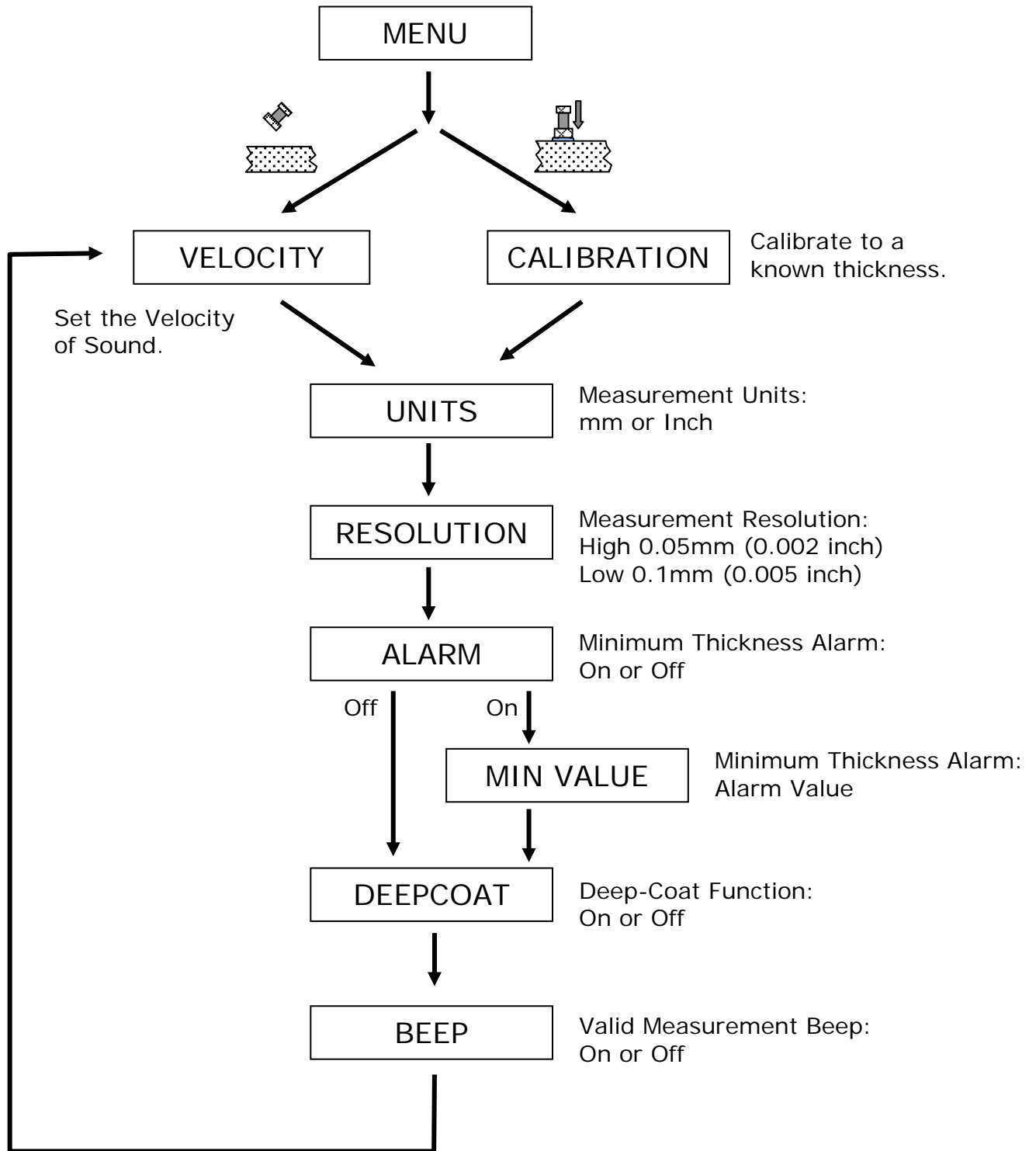



## Calibrating the Gauge

The Gauge is supplied tested and calibrated to BS EN 15317:2007. The Gauge will have been calibrated to measure thickness through steel (grade S355JO).

Either a 15 mm or 1/2 " test block is supplied with the kit so the Gauge can be quickly checked for correct operation. Note, this test block is not intended to be used for calibration of the Gauge.





The best way to calibrate the Gauge is to [Calibrate using a Known Thickness](#) using a sample of the material you intend to measure. This method determines the velocity of sound for the material sample, which will always be more accurate than using a 'general' velocity value. For calibration instructions see page 26.

If there is no test sample available the Gauge can be calibrated by [Setting the Velocity of Sound](#) directly. A [table](#) on page 44 at the back of this manual lists common materials and their velocity of sound value. For calibration instructions see page 27.

A third method is to leave the Gauge set to its factory-preset value for Steel [5920 m/s or 0.2332 in/us], and then use a Conversion Factor from the [table of velocities](#) on page 44.

### Calibrating to a known thickness (Single Point)

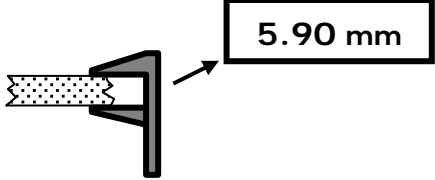
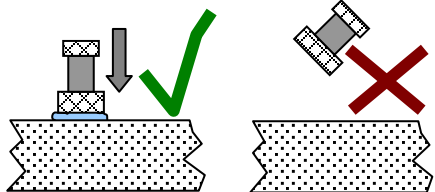
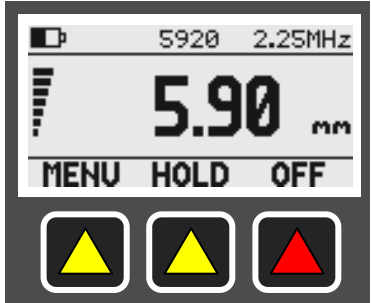
This method of calibrating the Gauge is the most accurate as the Gauge calculates the velocity of sound for the sample material.

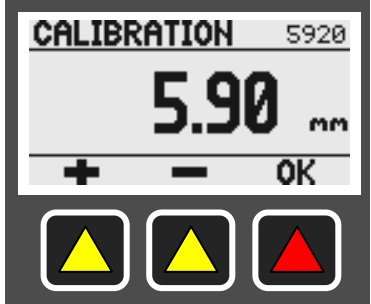
<p><b>1.</b></p>	<p>Accurately measure the thickness of your sample material.</p>	
<p><b>2.</b></p>	<p>Place the Probe on the sample so the Gauge is displaying a thickness value.</p>	
<p><b>3.</b></p>	<p>Press the MENU key to enter the gauge menu.</p>	
<p><b>4.</b></p>	<p>The CALIBRATION option is displayed in the menu.  Press the EDIT key to change the CALIBRATION setting.</p>	
<p><b>5.</b></p>	<p>Use the + - keys to change the thickness value as required, shown in large numbers.  The Velocity of Sound is shown at the top right of the screen.</p>	
<p><b>6.</b></p>	<p>Press the OK key to save the calibration values and exit.</p>	

### Setting the Velocity of Sound

The Gauge uses the Velocity of Sound value to calculate the material thickness value from the matched triple-echo time.

The current velocity of sound value is displayed in the centre at the top of the measuring screen. In the screen below '5920' means a velocity of 5920 m/s as the gauge is in metric.

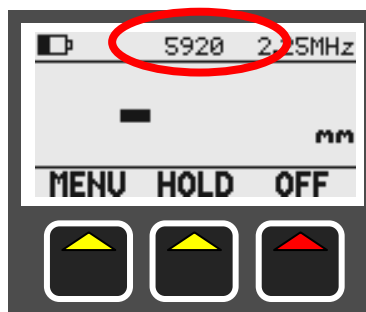

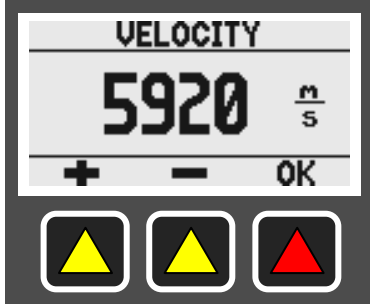

A [table](#) on page 44 of this manual lists velocity of sound values for common material.

<p><b>1.</b></p>	<p>Ensure the probe is not touching anything so the Gauge is not displaying a thickness value.</p>	
<p><b>2.</b></p>	<p>Press the MENU key to enter the gauge menu.</p>	
<p><b>3.</b></p>	<p>The VELOCITY setting is displayed in the menu.  Press the EDIT key to change the VELOCITY setting.</p>	

<b>4.</b>	Use the + - keys to change the VELOCITY value.	
<b>5.</b>	Press the OK key to save the new velocity value and exit.	

## Measurement Units

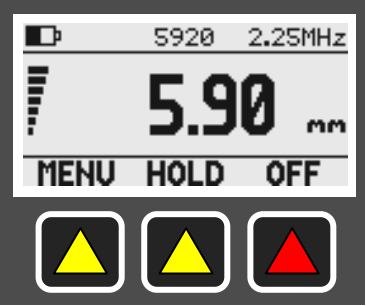
The Gauge can display thickness measurements in either Metric (mm) or Imperial (inch). Changing the measurement units does not affect the calibration.

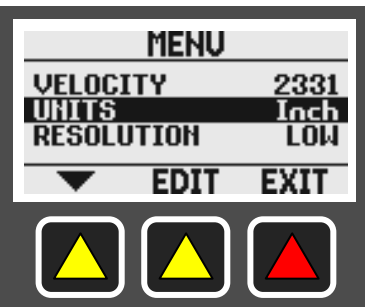
<p><b>1.</b></p>	<p>Press the MENU key to enter the gauge menu.</p>	 <p>The image shows the gauge's main display. At the top, it displays '5920 2.25MHz'. Below that, a large '5.90' is shown with 'mm' to its right. At the bottom of the display, it says 'MENU HOLD OFF'. Below the display are three buttons: two yellow triangles pointing up and one red triangle pointing up.</p>
<p><b>2.</b></p>	<p>Press the ▼ key to move down to the UNITS setting.</p>	 <p>The image shows the 'MENU' screen. It lists 'VELOCITY 5920', 'UNITS mm', and 'RESOLUTION HIGH'. The 'UNITS' line is highlighted with a black background. Below the list are 'EDIT' and 'EXIT' options, with a downward arrow icon to the left of 'EDIT'. Below the screen are the same three buttons as in the previous image.</p>
<p><b>3.</b></p>	<p>Press the EDIT key to change the UNITS setting:</p> <p>mm to inch</p> <p>inch to mm</p>	 <p>The image shows the 'MENU' screen after editing. It lists 'VELOCITY 2331', 'UNITS Inch', and 'RESOLUTION LOW'. The 'UNITS' line is highlighted. Below the list are 'EDIT' and 'EXIT' options, with a downward arrow icon to the left of 'EDIT'. Below the screen are the same three buttons.</p>
<p><b>4.</b></p>	<p>The gauge will automatically exit the menu and go back to the measuring screen.</p>	

## Resolution Setting

The Gauge can display the thickness measurements in two resolutions:

- High Resolution : 0.05 mm / 0.002 inch
- Low Resolution : 0.1 mm / 0.005 inch

To change the Resolution setting:

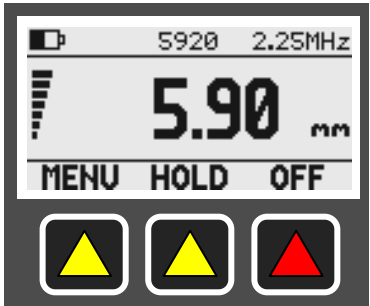
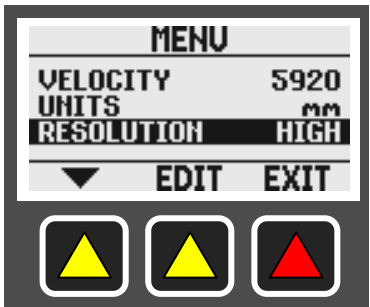
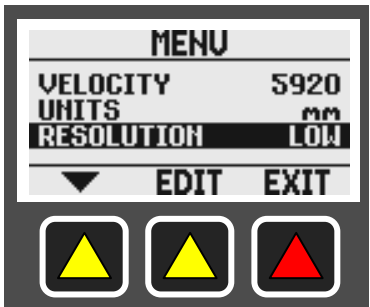
<p><b>1.</b></p>	<p>Press the MENU key to enter the gauge menu.</p>	
<p><b>2.</b></p>	<p>Press the ▼ key to move down to the RESOLUTION setting.</p>	
<p><b>3.</b></p>	<p>Press the EDIT key to change the RESOLUTION setting:</p> <p>High to Low</p> <p>Low to High</p>	
<p><b>4.</b></p>	<p>The gauge will automatically exit the menu and go back to the measuring screen.</p>	

### Minimum Thickness Alarm Function.

The gauge has a Minimum Thickness Alarm function that can be used to alert the operator when the measured thickness value is less than the set minimum value.

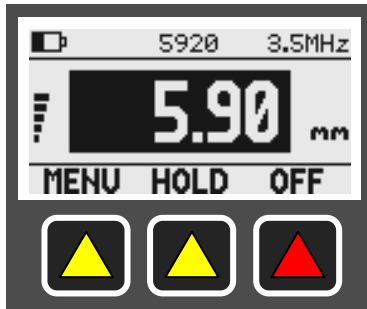

The gauge will alert the operator with a double 'beep' and also display the thickness value in a black box.

To turn the Alarm function on or off:

<p><b>1.</b></p>	<p>Press the MENU key to enter the gauge menu.</p>	<p>The image shows the gauge display with '5920' and '2.25MHz' at the top. The main display shows '5.90 mm'. Below the display, there are three buttons: a yellow triangle pointing up, another yellow triangle pointing up, and a red triangle pointing up. The text 'MENU HOLD OFF' is visible below the buttons.</p>
<p><b>2.</b></p>	<p>Press the ▼ key to move down to the ALARM setting.</p>	<p>The image shows the gauge menu. At the top, it says 'MENU'. Below that, there are three rows: 'UNITS mm', 'RESOLUTION HIGH', and 'ALARM OFF'. At the bottom, there are three buttons: a yellow triangle pointing up, another yellow triangle pointing up, and a red triangle pointing up. The text 'EDIT EXIT' is visible below the buttons.</p>
<p><b>3.</b></p>	<p>Press the EDIT key to change the ALARM setting from On to Off:</p> <p>When the ALARM is ON the MIN VALUE setting is shown.</p>	<p>The image shows the gauge menu. At the top, it says 'MENU'. Below that, there are three rows: 'RESOLUTION HIGH', 'ALARM ON', and 'MIN VALUE 1.00'. At the bottom, there are three buttons: a yellow triangle pointing up, another yellow triangle pointing up, and a red triangle pointing up. The text 'EDIT EXIT' is visible below the buttons.</p>

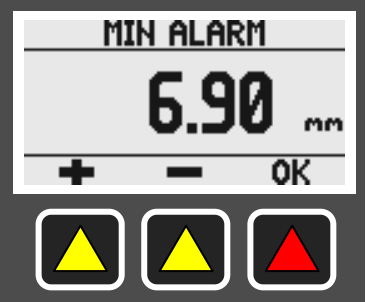
<b>4.</b>	To change the MIN ALARM value setting press the ▼ key to move down to the MIN VALUE setting.  Then press the EDIT key to change the MIN ALARM setting.	
<b>5.</b>	Use the + - keys to change the thickness value as required.  Press the OK key to save the new MIN ALARM value.	
<b>6.</b>	The gauge will automatically exit the menu and go back to the measuring screen.	





## Deep Coat Function

The gauge can normally measure metal thickness through protective coatings up to 6 mm thick<sup>2</sup>, however using the Deep-Coat function the gauge can measure through coatings up to 20 mm thick.

Only operate the gauge with Deep-Coat turned On when measuring through protective coatings thicker than 6 mm. Make sure Deep-Coat is turned Off when measuring metal with coatings less than 6mm.

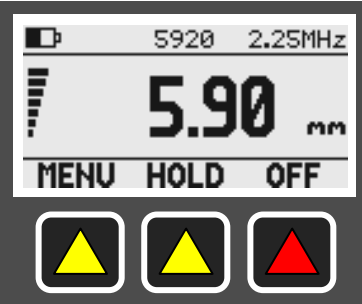
To turn the Deep-Coat function on or off:

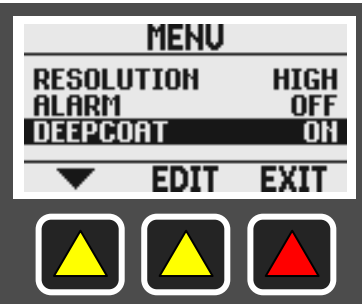
<p><b>1.</b></p>	<p>Press the MENU key to enter the gauge menu.</p>	
<p><b>2.</b></p>	<p>Press the ▼ key to move down to the DEEPCOAT setting.</p>	
<p><b>3.</b></p>	<p>Press the EDIT key to change the DEEPCOAT setting:</p>	
<p><b>4.</b></p>	<p>The gauge will automatically exit the menu and go back to the measuring screen.</p>	

<sup>2</sup> Depending on the properties of the coating and its velocity of sound.

## Deep Coat Warning Message

When the Deep Coat function is turned on a warning message is flashed at the top of the display.

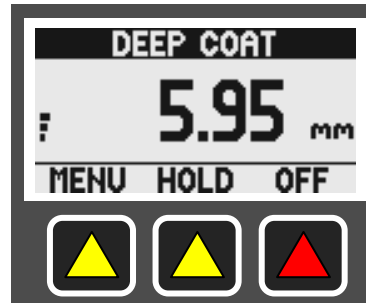

Deep Coat warning message.

Deep Coat mode must not be used when measuring through coatings less than 6 mm.

## Valid Thickness 'Beep' Function

The gauge can provide an audible 'beep' whenever a valid thickness measurement is taken. This means the operator can concentrate on probe positioning and listen for the 'beep' to signal a thickness measurement has been taken.

To turn the Beep function on or off:

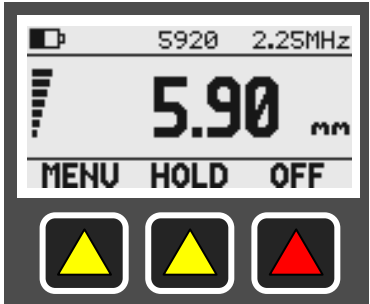
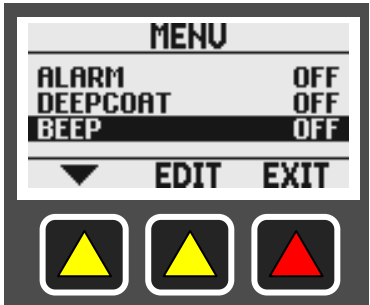
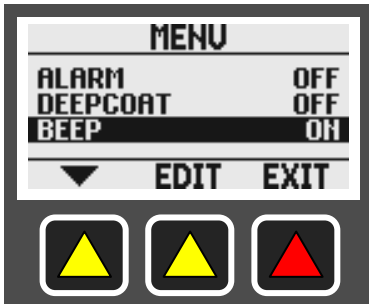
<p><b>1.</b></p>	<p>Press the MENU key to enter the gauge menu.</p>	 <p>The image shows the gauge's main display. At the top, it displays '5920 2.25MHz'. The main measurement is '5.90 mm'. Below the measurement, there are three buttons labeled 'MENU', 'HOLD', and 'OFF'. At the bottom, there are three physical buttons: two yellow triangles pointing up and one red triangle pointing up.</p>
<p><b>2.</b></p>	<p>Press the ▼ key to move down to the BEEP setting.</p>	 <p>The image shows the 'MENU' screen. It lists 'ALARM OFF', 'DEEPCOAT OFF', and 'BEEP OFF'. At the bottom, there are 'EDIT' and 'EXIT' options, and a downward arrow icon. The physical buttons at the bottom are the same as in the previous step.</p>
<p><b>3.</b></p>	<p>Press the EDIT key to change the BEEP setting:</p>	 <p>The image shows the 'MENU' screen, identical to the previous one, but the 'BEEP' setting is now 'ON'. The physical buttons at the bottom are the same.</p>
<p><b>4.</b></p>	<p>The gauge will automatically exit the menu and go back to the measuring screen.</p>	

## Automatic Probe Frequency Setting

The Gauge will automatically detect the frequency of the probe connected and set the Gauge accordingly. The probe frequency is displayed in the top right corner of the screen.

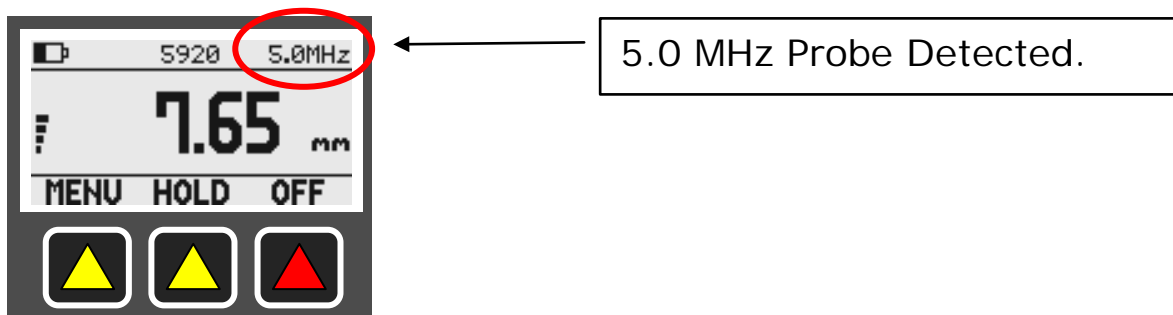
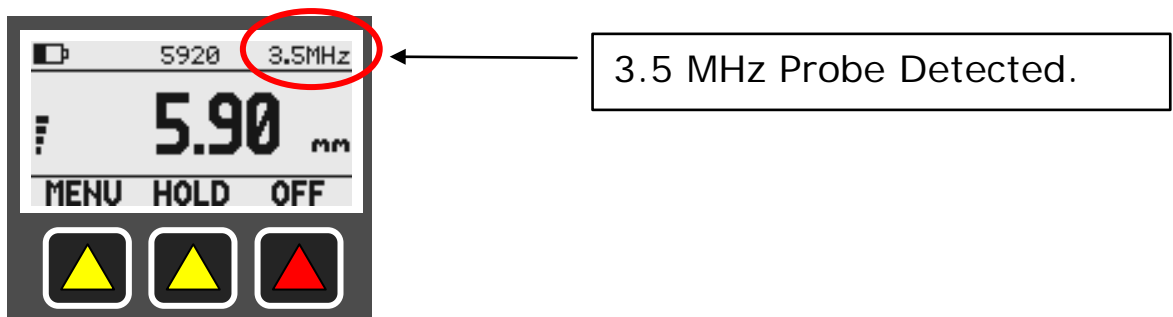
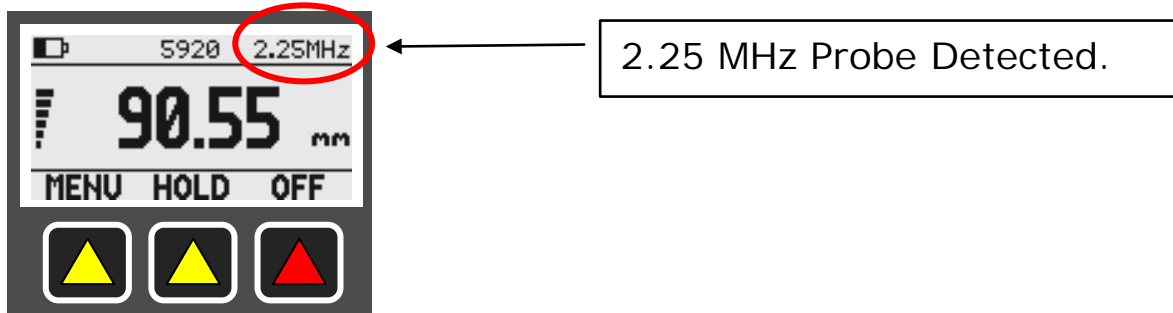

## 7. General Points On Thickness Gauging

On very rough surfaces and especially if both sides are badly corroded, it is often necessary to move the Probe around to locate a back wall reflector. Sometimes a slight rocking movement can help find reflectors which are otherwise impossible.

Badly corroded sections can also be soaked with a light lubricating oil to improve ultrasound coupling through to the good material.

Always ensure that there is plenty of couplant present for good contact, but beware that on a pitted surface the Gauge may just measure the couplant-filled pit, always avoid measuring directly over external pits.

Beware that in extreme conditions or if the plate is of poor quality and contains many inclusions the ultrasound will be scattered to such an extent that measurement may not be possible.

Beware that the multiple-echo technique will not work if the front and back surfaces of the material being measured are not close to parallel. Also note that long narrow bars cannot be gauged along their length with the multiple-echo method.

The Gauge should not be used near arc-welding equipment, as this affects its performance.

## 8. Troubleshooting

### The Gauge will not Switch On

- Are the batteries dead?
- Check the batteries are inserted correctly.

### Difficulty obtaining a Reading

If there is 1 single flashing bar on the display - this means the Gauge is not receiving any echoes:

- Check that the Probe-lead is properly connected to both Probe and Gauge.
- Check the condition of the lead, replace if necessary.

If there is mostly 1 fixed bar plus 1 flashing bar this means that the Gauge is having difficulty obtaining more than one echo:

- Check the Probe and its membrane are properly assembled.

If there are up to 3 fixed bars plus 1 flashing bar, but never any reading - this means the Gauge is receiving unrelated echoes from more than one reflector:

- On heavily corroded areas this is often a problem, note this as a problem area and try taking measurements in adjacent areas of the same material.
- Check the Gauge and Probe together on a test block, if there is still no reading the Gauge may require servicing.

### If Readings are Erratic or Unstable

- Check that the Probe-lead is properly connected to both Probe and Gauge.
- Check that the Probe and its membrane are correctly assembled with sufficient couplant between the probe face and membrane.
- Check the Probe-frequency is suitable for the probable minimum thickness of the material being measured. Probe frequencies too low cause doubling and tripling of the actual thickness.
- Check the gauge is not in Deep Coat mode.

## 9. The 4 Point Check

The most frequent reasons found to cause difficulty getting readings are:

### 1. Is the Probe-membrane fitted correctly?

- Check that there is a thin layer of oil between the membrane and Probe-face, and with no air-bubbles trapped. See [Changing the Membrane](#) on Page 22.

### 2. Is the Probe-lead OK?

- Check the probe lead is in good condition and is correctly inserted into the Probe and the Gauge. See [Connecting the Probe](#) on Page 10

### 3. Is there adequate couplant applied to the material being measured, and is the surface properly prepared?

- Check there is plenty of couplant gel applied and there are no air-gaps between the Probe and the material when measuring. See [Taking a Thickness Measurement](#) on Page 16.

### 4. Is the material measurable at all?

- Are the front and back faces of the material parallel?
- Is the material too heavily corroded?
- Is the material too thin for the Probe being used?

It is often worth confirming that the Gauge is operating OK using a test sample, and also to confirm that the material can actually be measured by ultrasonic multiple-echo thickness measurement.

## 10. Care and Servicing

### Cleaning the Gauge

- ✓ Clean the Gauge and accessories with a damp cloth. Use water with a mild detergent household cleaner.
- ✗ Do not use solvents to clean the Gauge.
- ✗ Do not use any abrasive cleaner, especially on the display window.
- ✗ Do not immerse the Gauge in liquid when cleaning.

### Batteries

- ✓ Always remove the batteries if the Gauge will not be used for more than a few days.
- ✓ Only use leak-proof batteries, Cygnus recommends Duracell Procell batteries.

### Environmental

- ✗ Do not immerse the Gauge in liquids.
- ✗ Do not subject the Gauge to temperatures greater than 60°C (140°F).
- ✗ Do not store the Gauge for long periods in conditions of high humidity.

### Repairs

- ✗ There are no user serviceable parts inside the Gauge. Therefore all repair work should be carried out by Cygnus Instruments or by an Authorised Cygnus Service dealer.



## Returning the Gauge for Servicing

A full Manufacturer's Factory Service is available from Cygnus Instruments.



The Complete Kit should always be returned for Service or Repair, including all Probes and Leads.

Cygnus Gauges are renowned for their reliability, very often problems with getting measurements are simply due to the way the Gauge is being used. See [Troubleshooting](#) on Page 38.

However, if you do need to return your Gauge for Repair please let us know the details of the problem, to help us guarantee the best possible service:

- Is the problem Intermittent Behaviour?
- Is there a problem turning the Gauge On?  
Or a problem with the Gauge turning itself Off?
- Does the Gauge constantly give Incorrect Readings, or Unsteady Readings?
- Is it not possible to Calibrate the Gauge?

# 11. Information

## Technical Specifications

General Attributes											
Size	85 mm x 115 mm x 25 mm (3.3" x 4.5" x 1.0")										
Weight	275 g (9.7 oz) Including Batteries										
Power Supply	2 x AA Alkaline Cells.										
Probe Sockets	Lemo 00 or BNC.										
Battery Operation Time	Approximately 30 hrs with alkaline 1500 mA/hr batteries.										
Battery Voltage Range	Min 1.8 V dc, Max 3.2 V dc										
Operating Temperature Range	-10°C to +50°C (14°F to 122°F)										
Storage Temperature Range	-10°C to +60°C (14°F to 140°F)										
Low Battery Indication	Display shows a battery level gauge and flashes a Low Battery warning message.										
PRF	602 Hz										
Monitor Outputs	N/A										
Through Coating Measurement.	Coatings up to 6 mm thick as standard. Coatings up to 20 mm thick in <b>Deep Coat</b> <sup>3</sup> mode.										
Materials	Sound Velocity from 2000 m/s to 7000 m/s [0.0800 in/us to 0.2780 in/us]										
Measurement Range	Measurement Ranges in Steel <sup>4</sup> : <table border="0" style="width: 100%;"> <tr> <td style="width: 30%;">2¼ MHz probe</td> <td style="width: 35%;">3 mm to 250 mm [0.120 in. to 10.00 in.]</td> <td style="width: 35%;"></td> </tr> <tr> <td>3½ MHz probe</td> <td>2 mm to 150 mm [0.080 in. to 6.000 in.]</td> <td></td> </tr> <tr> <td>5 MHz probe</td> <td>1 mm to 50 mm [0.040 in. to 2.000 in.]</td> <td></td> </tr> </table>		2¼ MHz probe	3 mm to 250 mm [0.120 in. to 10.00 in.]		3½ MHz probe	2 mm to 150 mm [0.080 in. to 6.000 in.]		5 MHz probe	1 mm to 50 mm [0.040 in. to 2.000 in.]	
2¼ MHz probe	3 mm to 250 mm [0.120 in. to 10.00 in.]										
3½ MHz probe	2 mm to 150 mm [0.080 in. to 6.000 in.]										
5 MHz probe	1 mm to 50 mm [0.040 in. to 2.000 in.]										
Accuracy	±0.05 mm (±0.002")	High Resolution Mode									
	±0.1 mm (±0.005")	Low Resolution Mode									
Resolution	0.05 mm (0.002")	High Resolution Mode									
	0.1 mm (0.005")	Low Resolution Mode									
Display											
Type of Display	Graphic LCD, 128 x 64 pixels, Monochrome. White LED Backlight.										
Display Size	Active Area 28 mm high x 47 mm wide.										
Transmitter											
Shape of Pulse	Square										
Pulse Energy : Voltage (peak-to-peak)	30 V p-p										

<sup>3</sup> To use **Deep Coat** mode see page 33.

<sup>4</sup> Tested using 150mm square test blocks.

Pulse Energy : Rise Time	25 ns (max)
Pulse Energy : Pulse Duration	110 ns / 135 ns / 230 ns (5 MHz, 3.5 MHz, 2.25 MHz)
<b>Receiver</b>	
Gain Control	Automatic Gain Control up to pre-set Maximum Gain value.
Frequency Range	1.5 MHz to 5.0 MHz (-6dB)
<b>Other Information</b>	
Data Output and Storage.	N/A
Calibration setting storage.	Calibration data stored in non-volatile EEprom memory.
Calibration Mechanisms.	N/A (Multiple Echo Gauge)
Display & Recall Facilities.	N/A
Display Response Time.	500 ms
Printer Output.	N/A
Environmental Rating.	IP65 & IP67
Compliance.	CE Marked. RoHS Compliant. BS EN 15317:2007

*Specifications are subject to change for product improvement*

## Table of Sound Velocities

Velocities will vary according to the precise grade and processing conditions of the material being measured.

 This table is included as a guide only.  
Wherever possible, the Gauge should always be calibrated on the material under test.

 These Velocities are given in good faith and are believed to be accurate within the limits described above.  
*No liability is accepted for errors.*

Velocities given are the compressional wave velocity  $c_l$ .

Material	Velocity of Sound (V)		Conversion Factor (f)
	m/s	in/us	
Aluminium (alloyed)	6380	0.2512	1.078
Aluminium (2014)	6320	0.2488	1.068
Aluminium (2024 T4)	6370	0.2508	1.076
Aluminium (2117 T4)	6500	0.2559	1.098
Brass (CuZn40)	4400	0.1732	0.743
Brass (Naval)	4330	0.1705	0.731
Brass (CuZn30)	4700	0.1850	0.794
Copper	4700 - 5000	0.1850 – 0.1969	0.794 – 0.845
Grey Cast Iron	4600	0.1811	0.777
Inconel	5700	0.2244	0.963
Lead	2150	0.0846	0.363
Monel	5400	0.2126	0.912
Nickel	5630	0.2217	0.951
Phosphor Bronze	3530	0.1390	0.596
Mild Steel	5920	0.2331	1.000
Tool Steel	5870	0.2311	0.992
Stainless Steel 302	5660	0.2228	0.956
Stainless Steel 347	5790	0.2279	0.978
Tin	3320	0.1307	0.561
Titanium	6100 - 6230	0.2402 – 0.2453	1.030 – 1.052

Tungsten Carbide	6660	0.2622	1.125
Epoxy Resin	2500	0.0986	0.422
Acrylic	2730	0.1076	0.461
Nylon (Polyamide)	2620	0.1032	0.443

### Reading Conversions

If only a few measurements are to be taken on a material other than Steel, it may be easier to leave the calibration set for Steel and merely convert the readings by multiplying by the **Conversion Factor** for the material being measured.

This method avoids unnecessary recalibration.

Example.

The Gauge is calibrated for Steel [5920 m/s], but the reading is being taken on Copper [4700 m/s] :

$$\begin{aligned}
 T &= t \times V_{\text{COPPER}} / V_{\text{STEEL}} \\
 &= t \times 4700 / 5920 \\
 &= \underline{t \times 0.794}
 \end{aligned}$$

thus :  $\underline{T = t \times f}$  [ where:  $f = V_{\text{COPPER}} / V_{\text{STEEL}}$  ]

where :

- T** = true thickness of Copper being measured
- t** = actual reading obtained
- f** = Conversion Factor (from table)
- $V_{\text{COPPER}}$  = Sound Velocity in Copper : 4700 m/s
- $V_{\text{STEEL}}$  = Sound Velocity in Steel : 5920 m/s

The **Conversion Factor f**: is given for various materials relative to steel in the Table of Sound Velocities

## 12. Accessories List

### Remote Probes with 1.35m (4'6") Lead

All probes are fully assembled and include a spare membrane pack and knurled ring locking key.

Part No.	Description
004-9310	Remote Probe 2.25MHz 13mm (1/2") BNC
004-9313	Remote Probe 3.5MHz 13mm (1/2") BNC
004-9314	Remote Probe 5.0MHz 6mm (1/4") Lemo 00
004-9316	Remote Probe 5.0MHz 13mm (1/2") BNC

**Lower frequency probes offer better penetration on heavy corrosion/coatings. Please refer to page Error! Bookmark not defined. for correct probe selection.**

## Marinised Probes with Cable Length to Order

For divers taking underwater thickness measurements down to 60m (approx 200ft) maximum whilst keeping the Cygnus 4 on the surface. Alternatively please visit:

[www.cygnus-instruments.com/english/cygnus1uw.html](http://www.cygnus-instruments.com/english/cygnus1uw.html) for full details on the Underwater thickness gauge.

Part No.	Description
002-9387	Marinised Probe 2.25MHz 13mm (1/2") UW remote probe with Lemo 1 plug
002-9388	Marinised Probe 2.25MHz 19mm (3/4") UW remote probe with Lemo 1 plug
002-9389	Marinised Probe 3.5MHz 13mm (1/2") UW remote probe with Lemo 1 plug
	Marinised Probe 5.0MHz 6mm (1/4") UW remote probe with Lemo 1 plug
002-9390	Marinised Probe 5.0MHz 6mm (1/4") UW remote probe with Lemo 1 plug
002-9391	Marinised Probe 5.0MHz 13mm (1/2") UW remote probe with Lemo 1 plug

**Lower frequency probes offer better penetration on heavy corrosion/coatings. Please refer to page Error! Bookmark not defined. for correct probe selection.**



**Note: Cygnus 4 is not intended for underwater use.**

### Probe Spares and Membranes

Polyurethane Membranes are for normal use on surface temperatures up to 75°C.

Teflon Membranes are for use on surface temperatures up to 150°C

Part No.	Description
001-3702	Standard Membranes (polyurethane) (20pk) 6mm (1/4")
001-3701	Standard Membranes (polyurethane) (20pk) 13mm (1/2")
001-3700	Standard Membranes (polyurethane) (20pk) 19mm (3/4")
001-4873	Teflon Membranes (10pk) (High Temperature) 6mm (1/4")
001-4874	Teflon Membranes (10pk) (High Temperature) 13mm (1/2")
001-4875	Teflon Membranes (10pk) (High Temperature) 19mm (3/4")



001-3706	Membrane Couplant
001-3707	UCA-2M Ultrasonic Couplant Gel (1 litre tub)
001-3708	UCA-2M Ultrasonic Couplant Gel (100 ml)
001-3717	Spares Kit – Cygnus 2,3 or 4 Gauge consisting of 1 x Standard Membranes (20pk) & Membrane Couplant

## Cables and Leads

Part No.	Description
004-0406	Probe Cable: Blue High-Flex BNC to Lemo 1 (STD) – 1.35m (4'6") As supplied with standard probe.
004-0401	Probe Cable: Lemo 00 to Lemo 1 (STD) – 1.35m (4'6"). For use with 6mm 5 MHz probe.

## Miscellaneous Spares

Part No.	Description
001-4850	Steel Test Block 15 mm
001-4851	Steel Test Block ½"
001-4852	Coated Test Block
001-4856	Carbon Steel Step Block 5-25 mm in 5 mm steps set in perspex

## Carry Cases

Part No.	Description
002-4834/4	Cygnus 2/4 Mk 4 carry case with foam
002-4835/4	Cygnus 2/4 Mk 4 silicone instrument sleeve with belt clip stud
002-4836/4	Cygnus 2/4 Mk 4 belt clip
002-4837/4	Cygnus 2/4 Mk 4 fabric accessories pouch

## 13. EU Declaration of Conformity

**Manufacturer** Cygnus Instruments Ltd.  
**Address** 30 Prince of Wales Road, Dorchester, Dorset. DT1 1PW.  
**Equipment** Cygnus 4 - Digital Ultrasonic Thickness Gauge (Mk4)  
**Description** Battery powered, hand held, digital ultrasonic thickness gauge.

---

### Directive 2004/108/EC - Electromagnetic Compatibility (EMC)

#### Applied EMC test standards:

**Emissions: EN 61326-1:2006**

Radiated disturbance - CISPR 11:2003, Class A

**Immunity: EN 61326-1:2006**

Electrostatic discharge - IEC 61000-4-2:2001

Radiated RF interference - IEC 61000-4-3:2002

(Test requirements for portable test and measurement equipment (Annex A))

---

On behalf of Cygnus Instruments Ltd, I declare that on the date the equipment accompanied by this declaration is placed on the market, the equipment conforms with all technical and regulatory requirements of the above listed directives.

Signed



Managing Director

## 14. Recycling and Disposal (EC Countries)

The WEEE Directive (Waste Electrical and Electronic Equipment 2002/96.EC) has been put into place to ensure that products are recycled using best available treatment, recovery and recycling techniques to ensure human health and high environmental protection.

The Gauge has been designed and manufactured with high quality materials and components which can be recycled and reused. It may contain hazardous substances that could impact health and the environment. In order to avoid the dissemination of those substances in our environment and to diminish the pressure on natural resources we encourage you to dispose of this product correctly.



DO NOT dispose of this product with general household waste.

DO dispose of the complete product including cables, plugs and accessories in the designed WEEE collection facilities.

This product may also be returned to the agent or manufacturer who supplied it for safe end-of-life disposal.

## 15. Index

- Accessories, 46
- Alarm, 31
  - Minimum Thickness Alarm, 31
- Automatic Power Off, 15
- Batteries
  - Fitting, 9
  - Incorrect Insertion, 9
  - Life, 19
  - Low Battery Warning, 20
  - NiCad, 9
  - NiMH, 9
- Beep, 35
- BS EN 15317:2007, 25
- Calibration, 25
  - Conversion Factor, 45
  - Known Thickness, 25
  - Single Point, 26
  - Velocity of Sound, 27
- Cleaning, 40
- coupling strength, 18
- Deep-Coat
  - Function, 33
  - Warning Message, 34
- Disposal, 51
- Echo Strength, 17
- Gauge Controls, 13
- Gauge Menu, 24
- Imperial, 29
- Keys, 14
  - function, 14
- LCD, 14
  - backlight, 14
- Measuring
  - narrow bars, 37
  - pitted surface, 37
  - rough surfaces, 37
- Metric, 29
- Neck Strap, 12
- Power button, 15
- Probes
  - Frequency, 36
  - Knurled Ring, 22
  - Locking Ring Key, 22
  - Membrane, 21
  - Membrane Couplant, 22
  - Probe Cable, 10
  - Selection, 21
  - Specifications, 23
- problems, 41
- pulse-echo, 6
- Recycling, 51
- Repair, 41
- Resolution, 30
- Service, 41
- Silicone Sleeve, 11
- Sound Velocities, 44
- Specifications, 43
- test block, 25
- Thickness Measurement, 16
- Triple Echo Verification, 6
- Troubleshooting, 38
- Units, 29
- unrelated echoes, 38
- WEEE Directive, 51