

Cygnus Heavy Duty

Operating Manual

Doc No. M4-CYG1HD-M-01_Iss6.doc
October 2021
(Mk4 Cygnus HD Gauges)

Contents

1. Important Notice	4
2. Introduction.....	5
Cygnus Heavy Duty Thickness Gauge.	5
Cygnus Instruments.....	6
Multiple Echo Measurements.	7
Triple Echo Verification.	7
3. Gauge Kit Contents	8
4. Gauge Preparation	9
Fitting the Battery Pack	9
Connecting the Probe and Nosecone	10
Removing the Nosecone.....	10
Replacing the O-Ring Seals	11
Checking the O-rings.....	13
5. Gauge Operation	14
Gauge Controls	14
Turning the Gauge On	15
Turning the Gauge Off.....	15
Automatic Power Off.....	15
Taking a Thickness Measurement	16
Echo-Strength Indicators	16
Battery Life.....	17
Low Battery Warning.....	17
Changing the Batteries	18
6. Probes & Membranes	19
Probe Selection	19
Changing the Membrane	20
Probe Selection & Specifications.....	21
Probe Frequency Identification.....	21
7. Gauge Setup	22
Gauge Menu Diagram.....	22
Connecting the Battery During Setup.....	23
Calibrating the Gauge.....	24
Calibrating to a known thickness (Single Point).....	25
Setting the Velocity of Sound.....	26
Measurement Units	27
Resolution Setting	28

Automatic Probe Frequency Setting	29
8. General Points On Thickness Gauging	30
9. Troubleshooting	31
The Gauge will not Switch On	31
Difficulty obtaining a Reading	31
If Readings are Erratic or Unstable	31
10. The 5 Point Check	32
11. Care and Servicing	33
Cleaning the Gauge.....	33
O-Ring Seals.....	33
Probe Membranes	33
Batteries	33
Environmental.....	33
Repairs	33
Returning the Gauge for Servicing.....	34
12. Information	35
Technical Specifications	35
Table of Sound Velocities	37
Reading Conversions	38
13. Spare Parts List.	39
14. Recycling and Disposal (EC Countries).....	40
15. Index	41

1. Important Notice



This following important information must be read and understood by all users of Cygnus ultrasonic thickness gauges.

The correct use of Cygnus ultrasonic thickness gauges requires identification of the correct equipment for the specific application coupled with an appropriately trained and qualified operator or technician. The incorrect use of this equipment, along with its incorrect calibration, can result in serious financial loss due to damage to components, facilities, personal injury and even death.

Neither Cygnus Instruments nor any of its employees or representatives can be held responsible for improper use of this equipment. Proper training, a complete understanding of ultrasonic wave propagation, thorough reading of this manual, proper transducer selection, correct zeroing of the transducer, correct sound velocity, correct use of the appropriate test blocks, proper cable length and proper couplant selection all play a factor in successful ultrasonic thickness gauging. Of critical importance is the process of complete and accurate calibration of the instrument.

This manual will provide instructions in the set up and operation of the thickness gauge. Additional factors that can affect the use of ultrasonic equipment are beyond the scope of this manual and to that end it is understood that the operator of this equipment is a well-trained inspector qualified by either their own organisation or another outside agency to the appropriate level of both theory and practical application of ultrasonics.

Therefore Cygnus Instruments recommends that users of its ultrasonic thickness gauges should be formally qualified to a minimum of UT "Level 1" (ASNT or PCN) which will provide approximately 40 hours of training.

2. Introduction

Cygnus Heavy Duty Thickness Gauge.

The **Cygnus Heavy Duty Multiple-Echo Ultrasonic Thickness Gauge** is a rugged, handheld, battery-powered instrument designed for high-reliability thickness measurement using the multiple-echo technique.

The Cygnus HD gauge has a dual IP65/IP67 rating which means it is dust tight, shower proof and can withstand temporary immersion in water to a depth of 1m for up to 30 minutes.



The Cygnus HD gauge is not rated for underwater use.

The gauge is powered by three AA alkaline or rechargeable batteries. Measurements can be displayed in Metric (mm) or Imperial (inch) units, measurement resolution can be selected for either 0.1 or 0.05 mm, (0.005 inch or 0.002 inch). The Gauge has a side-mounted red LED display which can easily be read in low-light situations.

Crystal-controlled Calibration provides stability and accuracy. The gauge can easily be calibrated to a known thickness or to a known Velocity of Sound. Velocity of Sound is displayed in either m/s or in/ μ s, depending on the current selection for Measurement Units



The Gauge is a solid-state electronic instrument which, under normal operating conditions, will give many years of active service.

Although designed for ease of operation first time users should carefully read this manual to familiarise themselves with the features of the Gauge.

Cygnus Instruments.

Cygnus Instruments Limited, founded in 1983, pioneered the development of the Digital *Ultrasonic Multiple-Echo Technique* used for measurement through coatings. This has long since been the standard required to ensure that accurate measurements are taken without the need to zero the Gauge or remove any coatings first.

Our philosophy is to work closely our customers to provide high quality products, engineered to serve heavy industry & harsh environments. Cygnus Ultrasonic thickness gauges are designed to be reliable and simple to use. We have an unrivalled reputation in over 45 countries around the world.



CYGNUS Instruments Ltd.

Cygnus House, 30 Prince of Wales Road,
Dorchester, Dorset, DT1 1PW England.
Website: www.cygnus-instruments.com
Tel: 00 44 (0) 1305 265533
Fax: 00 44 (0) 1305 269960
sales@cygnus-instruments.com

Cygnus UAE Cygnus Instruments Middle East

P.O. Box 127267
Jebel Ali Free Zone (JAFZA)
Dubai
UAE
Website: www.cygnus-instruments.com
Telephone: +971 50 3459305
E-mail: sales@cygnus-instruments.com

CYGNUS Instruments Inc.

Phillips Hwy Commerce Park
6900 Phillips Hwy, Suite 8
Jacksonville, FL 32216
Tel: 00 1 410 267 9771
Fax: 00 1 410 268 2013
www.cygnusinstruments.com
sales@cygnusinstruments.com

CYGNUS Singapore (S) Pty. Ltd.

63 Jalan Pemimpin #05-01,
Pemimpin Industrial Building,
577219 Singapore.
Tel: (+65) 6252 5909
Fax: (+65) 6251 1318
www.cygnus-instruments.sg
sales@cygnus-instruments.sg

Multiple Echo Measurements.

The Gauge works on the pulse-echo principle. The Probe transmits a very short pulse of ultrasound which enters the test piece. The Probe then acts as a receiver listening for return echoes, converting them into electrical signals which are processed to produce timing information that can be used to determine the material thickness.

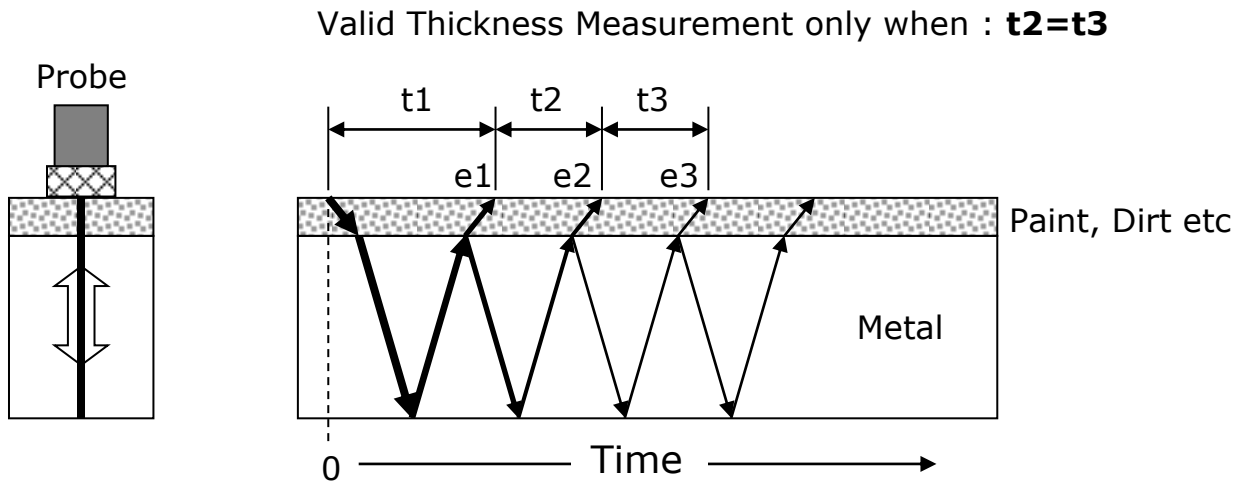

The *multiple-echo* beam travel is depicted above, spread out in time, to illustrate the timing method. In reality the beam path is straight and perpendicular to the surface as the ultrasonic energy reverberates up and down within the metal (shown on the left). Each time an echo is reflected back down, a small portion of the energy comes up through the coatings and is detected by the Probe which acts as a receiver (e_1 , e_2 and e_3).

The delay between echoes at the Probe-face (t_2 and t_3) is exactly equal to the time taken to pass through the metal twice, therefore coatings such as paint are ignored and the measurement displayed is the metal thickness only.

Triple Echo Verification.

The Gauge requires 3 equi-spaced return echoes in order to calculate a thickness measurement value ($t_2=t_3$). This method ensures the Gauge only displays valid thickness values, the three echoes provide a reliable method of signal verification. This process is referred to as Triple Echo Verification.

3. Gauge Kit Contents



1. Cygnus HD Gauge Body.
2. Battery Pack.
3. Nosecone, Cable & Remote Probe (1.5 m).
4. Couplant Gel.
5. Membrane Couplant.
6. Accessories : Spare O-Rings, Spare Membranes, Membrane Locking Ring Key, 15 mm (1/2") Test block, Tommy Bar.

The Operating Manual and Documentation is attached in the lid of the case.

4. Gauge Preparation

The battery pack is supplied fitted with Duracell alkaline batteries. Just fit the battery pack, screw on the nosecone/probe assembly, turn on the power and you are ready to take thickness measurements.

Fitting the Battery Pack

The Gauge is supplied with a removable battery pack which is screwed onto the gauge body by hand. Do not over-tighten the battery pack – hand tight is sufficient.

When the battery pack is correctly fitted there should be no gap between the battery pack and gauge body.



Correctly Fitted



Incorrectly Fitted

- ⚠ When changing the battery it is advisable to check the O-rings (page 13) and if necessary fit new O-ring seals to the gauge body. See 'Replacing the O-Ring Seals' on page 11.

Connecting the Probe and Nosecone

The Probe is connected to the nosecone via a length of coaxial cable, the nosecone then screws on to the end of the Gauge body.

When screwing the nosecone onto the Gauge body tighten only by hand, ensuring there is no gap between the nosecone and Gauge.

 DO NOT use the tommy bar to tighten the nosecone.



Correctly Fitted

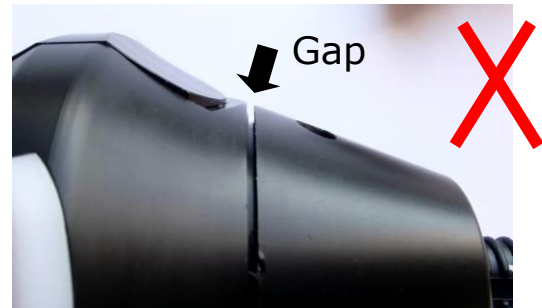

Incorrectly Fitted

Removing the Nosecone

The nosecone can be difficult to remove when the O-rings have been compressed so a tommy bar is supplied with the kit to allow extra leverage to be applied to 'break' the seal. Fit the tommy bar into the hole in the nosecone then unscrew using the tommy bar as a lever.



Replacing the O-Ring Seals

There are three O-ring seals fitted to the Gauge body, two for the battery and one for the nosecone. Spare O-rings are included in the kit, the different O-rings are marked A & D.



1. Remove the old O-rings and destroy them.

Do not use a sharp instrument to remove the O-rings as damage to the sealing area may occur

2. Clean the O-ring locations removing all grease and dirt.
3. Gently fit the new O-rings into position.

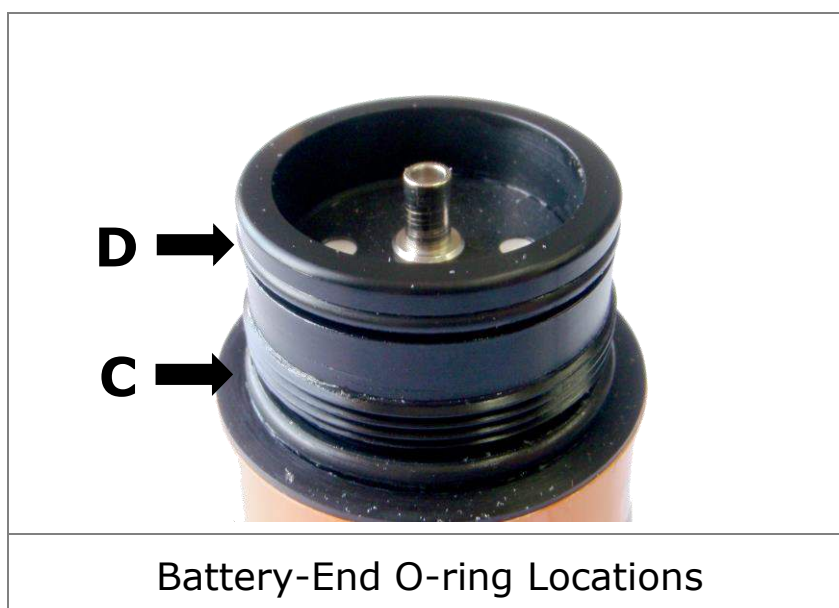

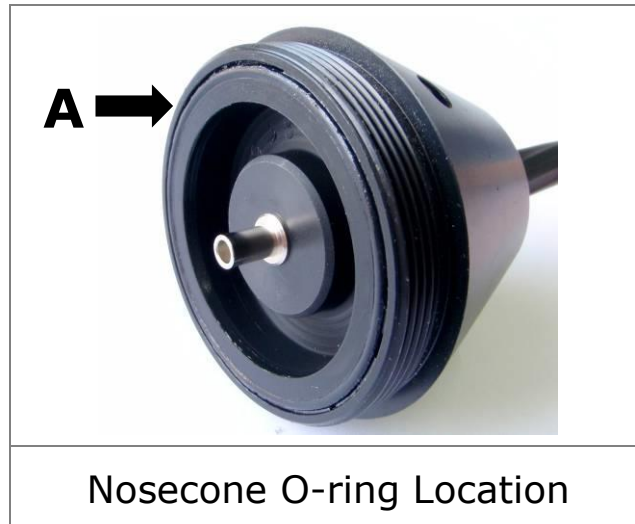

Nosecone O-ring Location

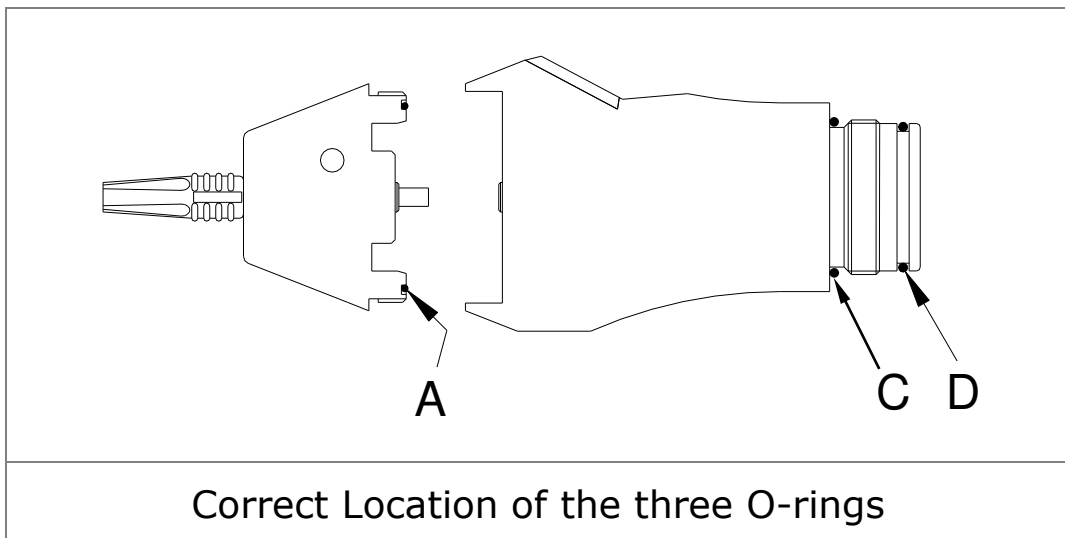

Correct Location of the three O-rings



Be careful not to fit the 'A' O-ring in the wrong position, this is a common mistake that will cause incorrect gauge operation.

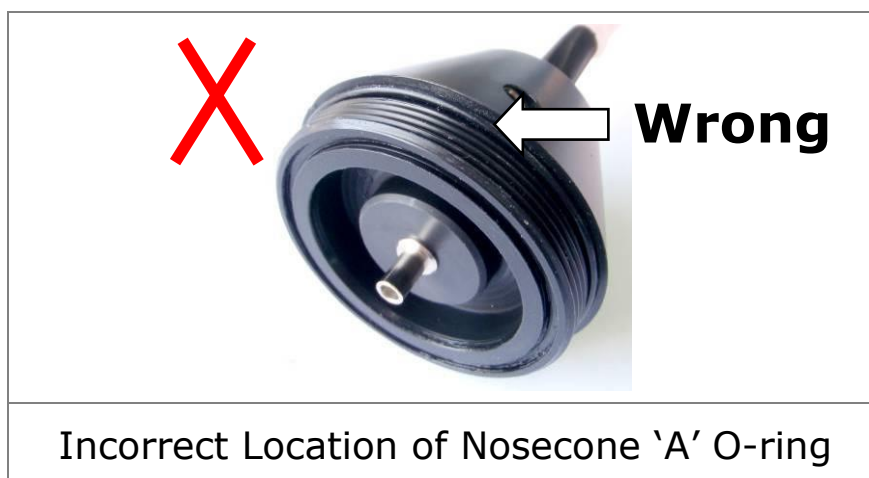

Incorrect Location of Nosecone 'A' O-ring

Checking the O-rings

To ensure the gauge retains its IP65/IP67 protection rating the O-rings must be frequently checked when you remove the battery pack or nosecone. It is recommended to replace the O-rings if in any doubt as to their condition or age.

- ✓ Check the O-rings whenever you remove the battery.
- ✓ Check the O-rings whenever you remove the nosecone.
- ✗ Do not use old or damaged O-rings.
- ✗ Never use the Gauge without any O-rings fitted.

Spare O-rings are included in the Kit and can be ordered from Cygnus Instruments (see 'Spare Parts List.' on page 39).

Things to look for when inspecting the O-rings are:





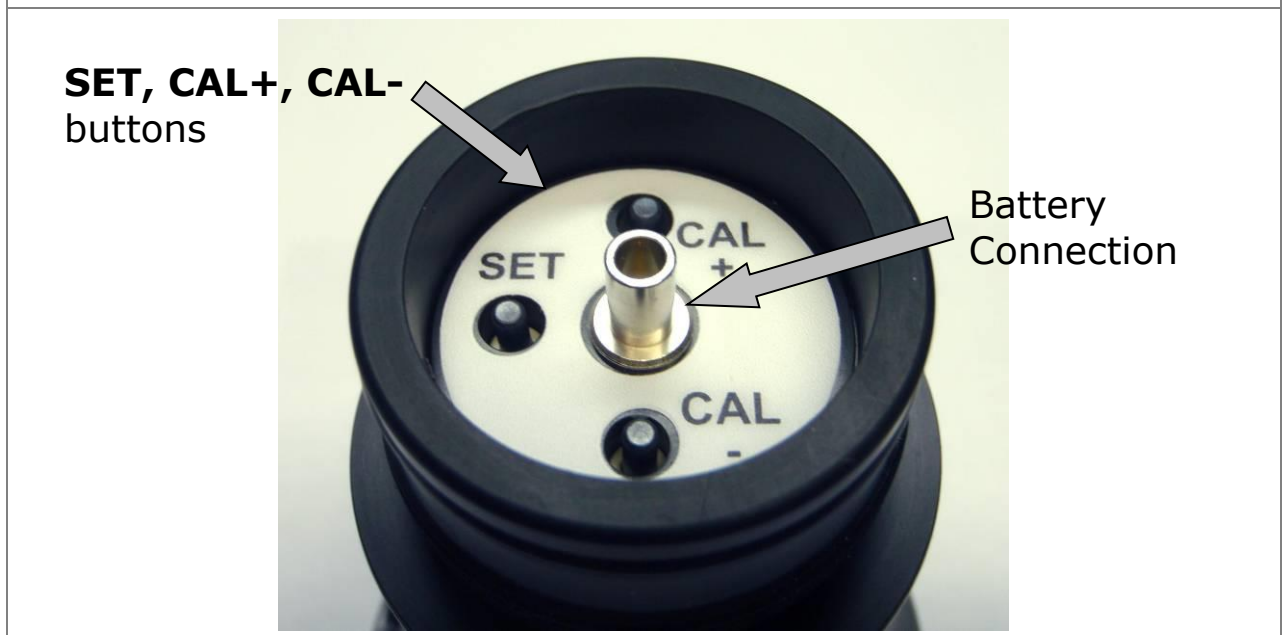

- Any flats or signs of wear.
- Any signs of pinching or trapping.
- Any cuts or cracks.

5. Gauge Operation



Gauge Controls



Turning the Gauge On

1.	Press the Power button forward,	
2.	The display test '8888' appears,	
3.	The firmware version is displayed,	
4.	The hardware version is displayed,	
5.	The probe frequency is displayed,	
6.	The velocity of sound is displayed,	
7.	The Gauge type is displayed,	
8.	The Gauge is ready to use.	



Turning the Gauge Off

1.	Press the Power button forward briefly,	
2.	The display scrolls 'shutoff' and the Gauge turns off.	 

Automatic Power Off

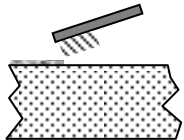
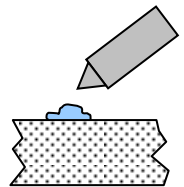
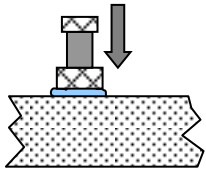

The Gauge will turn off automatically 5 minutes after the last thickness measurement was taken.

Taking a Thickness Measurement

<p>1.</p>	<p>Remove any loose rust, dirt or loose coatings and brush the test area clean.</p>	
<p>2</p>	<p>Apply couplant to the test surface.</p>	
<p>3.</p>	<p>Place the probe-face on the prepared, test surface and make firm contact applying gentle pressure.</p>	
<p>4.</p>	<p>The Gauge will display a thickness measurement or an indication of Echo Strength if no valid measurement has been found.</p>	

Echo-Strength Indicators

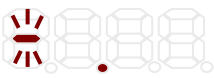
Should the Gauge be unable to detect a stable multiple echo signal it displays an Echo Strength indication to help the operator locate a suitable position.

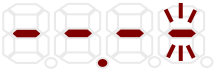
<p>1.</p>	<p>1 Bar Flashing: No echoes detected.</p>	
<p>2.</p>	<p>1 steady + 1 Bar Flashing: Only 1 echo detected.</p>	
<p>3.</p>	<p>2 steady + 1 Bar Flashing: Only 2 echoes detected.</p>	
<p>4.</p>	<p>3 steady + 1 Bar Flashing: 3 echoes detected but they are not related.</p>	

To help obtain a multiple echo reading the operator should continue to move the probe around to locate a suitable reflector, using a slight rocking motion.

Battery Life

The Gauge will operate continuously for approximately 16 hrs when fitted with alkaline batteries. Cygnus supply and recommend Duracell® Procell MN1500 alkaline batteries.

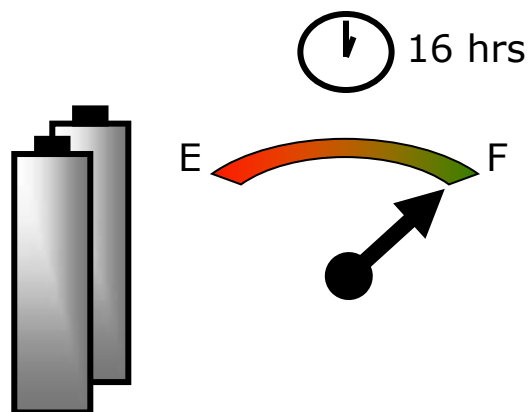

Low Battery Warning

The Gauge will periodically flash a Low Battery warning message when the batteries are getting low. You may still be able to continue taking measurements for about 1/2 hour.

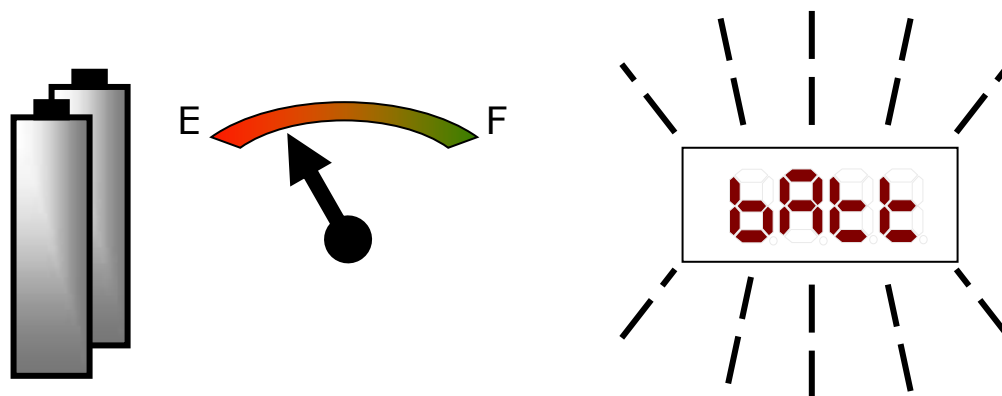

When the batteries are discharged the Gauge will flash the low battery warning for 5 seconds then turn of automatically.

Changing the Batteries

The remove the batteries from the battery pack;

1. Unscrew the battery pack from the gauge body.
2. Tap the gauge end of the battery pack into the palm of your hand – the internal battery holder will slide out,



3. Replace the three batteries,



Note.

The SPRING is the negative (-) contact.

4. Slide the battery holder back inside the battery pack case.

6. Probes & Membranes

 The Gauge should only be used with Soft-Faced probes supplied by Cygnus Instruments.

Cygnus Soft-Faced probes are fitted with a Polyurethane Membrane which provides better contact on rough surfaces and protects the probe face from wear, prolonging the life of the probe.

Check the membrane regularly as it is important the membrane is changed as soon as it shows any signs of wear.

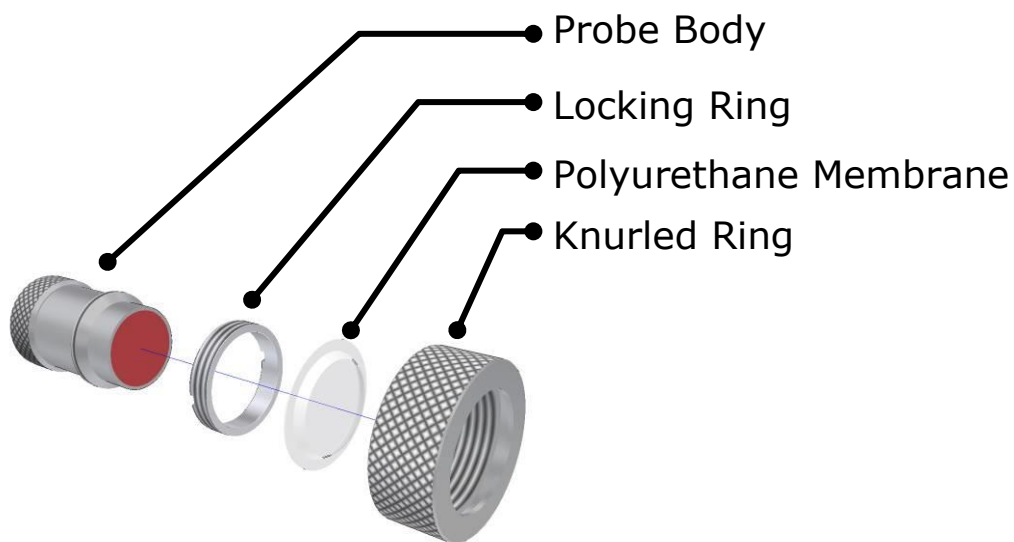





Probe Selection

Apart from the physical limitation of the probe size, the diameter of the probe face (crystal) and the frequency affects the probe performance, generally:

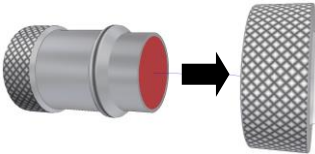
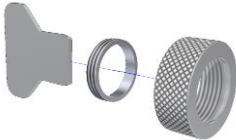
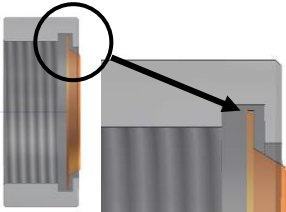
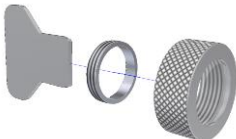
- Large diameter probes produce more energy which gives better performance on heavily corroded or coated materials.
- Higher Frequency probes produce a narrower focused beam which is better when looking for small features or on thin materials.

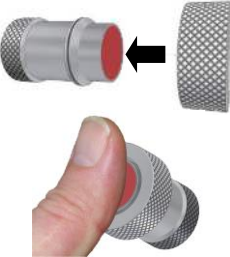
Changing the Membrane

<p>1.</p>	<p>Unscrew the Knurled Ring from the end of the Probe</p>	
<p>2.</p>	<p>Use the Locking Ring Key to unscrew the Locking Ring from inside the Knurled Ring. The old membrane can then be removed and discarded.</p>	
<p>3.</p>	<p>Place a new membrane into the end of the Knurled Ring ensuring it locates in the groove.</p>	
<p>4.</p>	<p>Screw the Locking Ring back inside the Knurled Ring and tighten with the Locking Ring Key.</p>	
<p>5.</p>	<p>Place a few drops of Membrane Couplant on to the probe face.</p>	
<p>6.</p>	<p>Screw the Knurled Ring back onto the probe. Use your thumb to squeeze the couplant from under the membrane as you tighten the Knurled Ring down</p>	
<p>7.</p>	<p>You should see the membrane has a very thin film of couplant between itself and the probe face with <u>no air bubbles</u>.</p>	

Probe Selection & Specifications

Crystal Diameter	Frequency	Measurement Range	Application
13 mm ½ inch	2¼ MHz	3.0 – 250 mm ¹ 0.12 – 10 inch	This is the standard probe – suitable for most applications.
13 mm ½ inch	3½ MHz	2.0 – 150 mm 0.08 – 6 inch	Suitable for measurement on thinner sections where surfaces are relatively rough
6 mm ¼ inch	5 MHz	1.0 – 50 mm 0.04 – 2 inch	The higher frequency and narrower beam makes this Probe ideal for measuring small-bore tubing, thin section plate and other areas where access is limited.
13 mm ½ inch	5 MHz	1.0 – 50 mm 0.04 – 2 inch	Ideal for thin sections without heavy corrosion.

Probe Frequency Identification

The frequency of Cygnus probes is indicated by colour;

Red = 2.25 MHz	Orange = 3.5 MHz	Black = 5.0 MHz
-----------------------	-------------------------	------------------------

Old Style Probes	Inox Remote Probes
Coloured Probe Face 	Coloured Band on Probe Cap 

¹ To measure thicknesses on tall thin cylinders or columns the height-width ratio should be no less than 1.0:0.6 (Height:Width) otherwise side reflections prevent measurement.

7. Gauge Setup

Gauge Menu Diagram

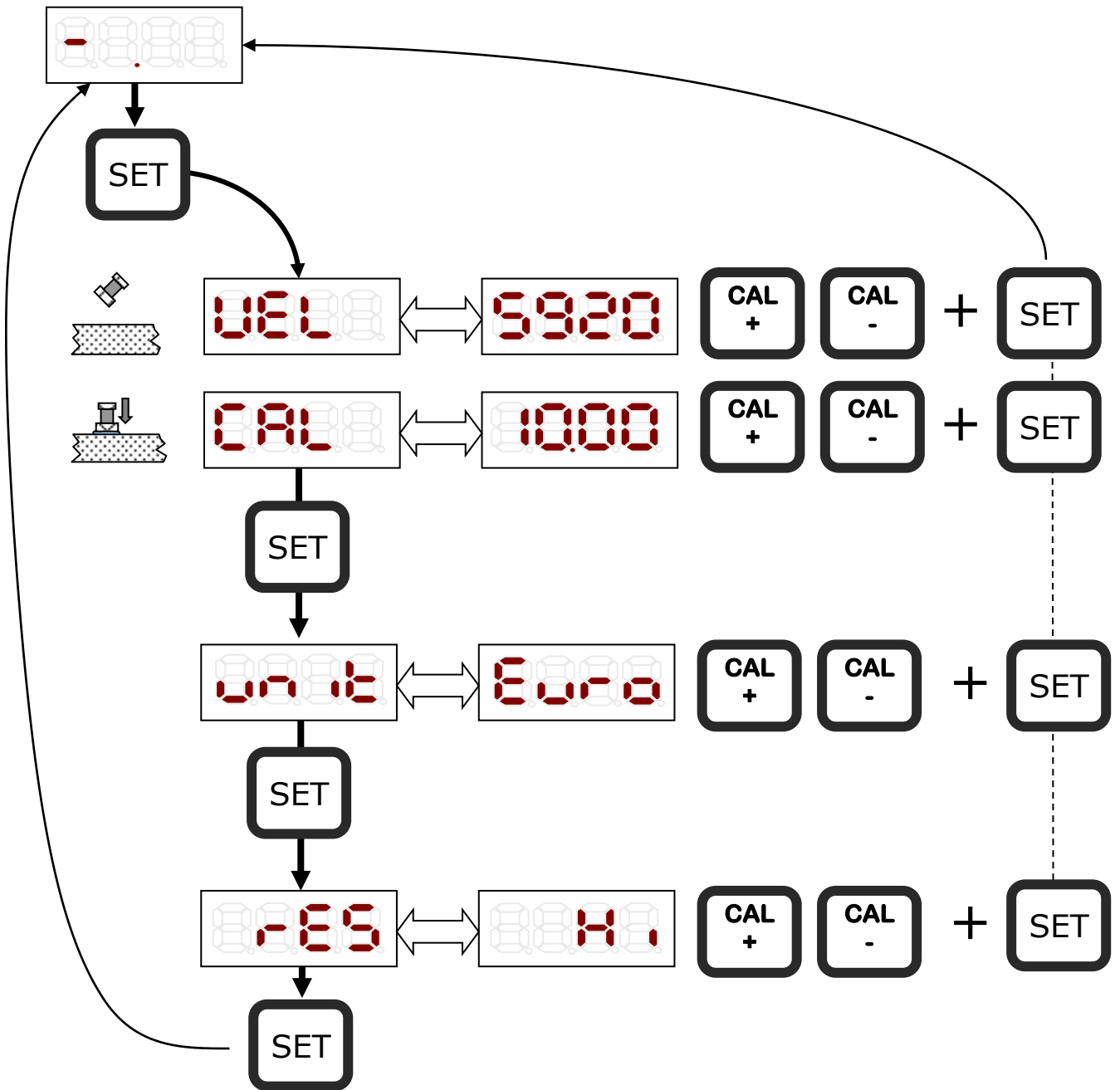

Connecting the Battery During Setup

To provide access to the setup buttons connect the battery pack to the gauge body using the calibration jumper lead supplied with the kit. Connect this lead from the battery to the connection at the battery end of the gauge as shown below.



Calibration Jumper Lead

Calibrating the Gauge

The Gauge is supplied tested and calibrated. The Gauge will have been calibrated to measure thickness through steel (grade S355JO).

Either a 15mm or ½" test block is supplied with the kit so the Gauge can be quickly checked for correct operation. Note, this test block is not intended to be used for calibration of the Gauge and may not indicate an exact 15.00 mm.





The best way to calibrate the Gauge is to Calibrate using a Known Thickness using a sample of the material you intend to measure. This method determines the velocity of sound for the material sample, which will always be more accurate than using a 'general' velocity value. For calibration instructions see page 25.

If there is no test sample available the Gauge can be calibrated by Setting the Velocity of Sound directly. A table on page 37 at the back of this manual lists common materials and their velocity of sound value. For calibration instructions see page 26.

A third method is to leave the Gauge set to its factory-preset value for Steel [5920 m/s or 0.2332 in/us], and then use a Conversion Factor from the table of velocities on page 37.

Calibrating to a known thickness (Single Point)

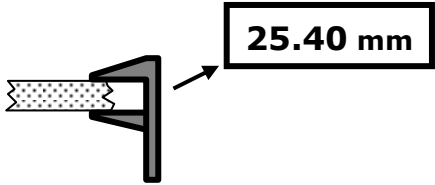
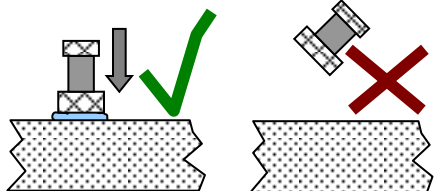
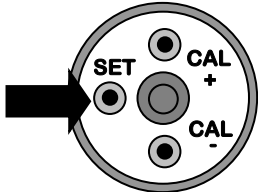

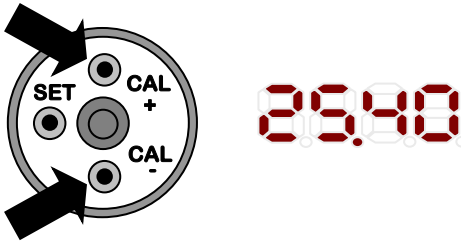
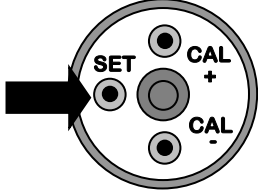
This method of calibrating the Gauge is the most accurate as the Gauge calculates the velocity of sound for the sample material.

<p>1.</p>	<p>Accurately measure the thickness of your sample material.</p>	
<p>2.</p>	<p>Place the Probe on the sample so the Gauge is displaying a thickness value.</p>	
<p>3.</p>	<p>Press the SET button once to display the Gauge setup menu.</p>	
<p>4.</p>	<p>The display flashes the current thickness value.</p>	
<p>5.</p>	<p>Use the CAL+ and CAL- buttons to change the thickness value until it reads the correct value as measured in '1'.</p>	
<p>6.</p>	<p>Press the SET button to save the new calibration.</p>	

Setting the Velocity of Sound

The Gauge uses the Velocity of Sound value to calculate the material thickness value from the matched triple-echo time.

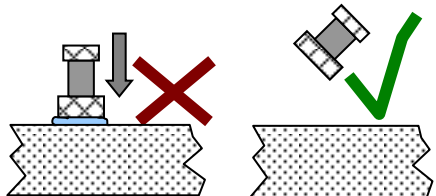
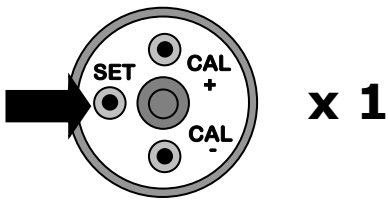
A table at the back of this manual lists velocity of sound values for common material.

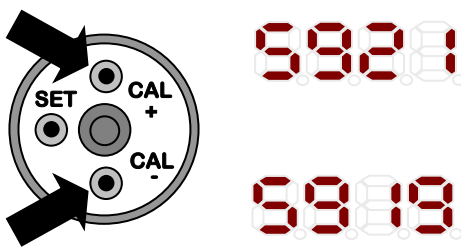
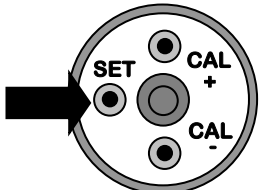
<p>1.</p>	<p>Ensure the probe is not touching anything so the Gauge is not displaying a thickness value.</p>	
<p>2.</p>	<p>Press the SET button once to display the Gauge setup menu.</p>	
<p>3.</p>	<p>The display flashes the current Velocity of Sound value.</p>	
<p>4.</p>	<p>Use the CAL+ and CAL- buttons to change the value.</p>	
<p>5.</p>	<p>Press the SET button to save the new velocity value.</p>	

Measurement Units

The Gauge can display thickness measurements in either Metric (mm) or Imperial (inch). Changing the measurement units will not affect the calibration.

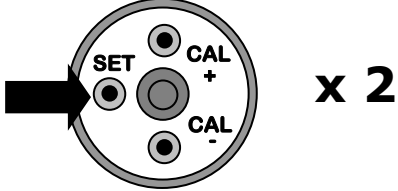
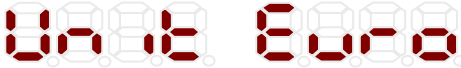
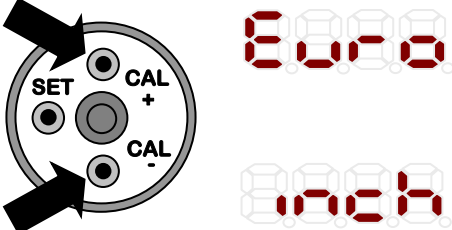
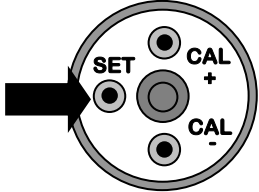

<p>1.</p>	<p>Press the SET button 2 times to enter the Gauge setup menu and display the Measurement Units.</p>	
<p>2.</p>	<p>The display flashes the current Measurement Unit value.</p>	
<p>3.</p>	<p>Use the CAL+ and CAL- buttons to change between the two unit settings.</p> <p>Note. Euro = mm</p>	
<p>4.</p>	<p>Press the SET button to save the new Measurement Units.</p>	

Resolution Setting

The Gauge can display the thickness measurements in two resolutions:

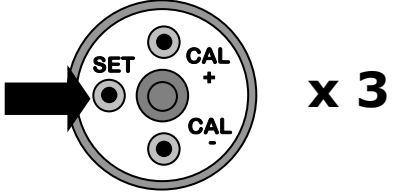

- High Resolution : 0.05 mm / 0.002 inch
- Low Resolution : 0.1 mm / 0.005 inch

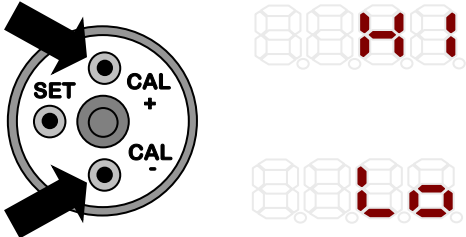
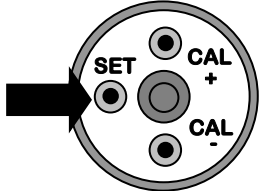
To change the Resolution setting:

<p>1.</p>	<p>Press the SET button 3 times to enter the Gauge setup menu and display the Resolution setting.</p>	
<p>2.</p>	<p>The display flashes the current Resolution setting.</p>	
<p>3.</p>	<p>Use the CAL+ and CAL- buttons to change between the two resolution settings.</p>	
<p>4.</p>	<p>Press the SET button to save the new Resolution setting.</p>	

Automatic Probe Frequency Setting.

The Gauge will automatically detect the frequency of the probe connected and set the Gauge accordingly. When a probe of a different frequency is connected the display will briefly show the new probe frequency detected.

	Probe Connected	Display
	2.25 MHz Probe	
	3.5 MHz Probe	
	5.0 MHz Probe	

8. General Points On Thickness Gauging

On very rough surfaces and especially if both sides are badly corroded, it is often necessary to move the Probe around to locate a back wall reflector. Sometimes a slight rocking movement can help find reflectors which are otherwise impossible.

Badly corroded sections can also be soaked with a light lubricating oil to improve ultrasound coupling through to the good material.

Always ensure that there is plenty of couplant present for good contact, but beware that on a pitted surface the Gauge may just measure the couplant-filled pit, always avoid measuring directly over external pits.

Beware that in extreme conditions or if the plate is of poor quality and contains many inclusions the ultrasound will be scattered to such an extent that measurement may not be possible.

Beware that the multiple-echo technique will not work if the front and back surfaces of the material being measured are not close to parallel. Also note that long narrow bars cannot be gauged along their length with the multiple-echo method.

The Gauge should not be used near arc-welding equipment, as this affects its performance.

9. Troubleshooting

The Gauge will not Switch On

- Are the batteries flat?
- Check the battery pack is fitted correctly.

Difficulty obtaining a Reading

If there is 1 single flashing bar on the display – this means the Gauge is not receiving any echoes:

- Check that the Probe-lead is properly connected to both Probe and Gauge.
- Check the condition of the lead, replace if necessary.

If there is mostly 1 fixed bar plus 1 flashing bar this means that the Gauge is having difficulty obtaining more than one echo:

- Check the Probe and its membrane are properly assembled.

If there are up to 3 fixed bars plus 1 flashing bar, but never any reading – this means the Gauge is receiving unrelated echoes from more than one reflector:

- On heavily corroded areas this is often a problem, try and take measurements in adjacent areas of the same material.
- Check the Gauge and Probe together on a test block, if there is still no reading the Gauge may require servicing.

If Readings are Erratic or Unstable

- Check that the Probe-lead is properly connected to both Probe and Gauge.
- Check that the Probe and its membrane are correctly assembled with sufficient couplant between the probe face and membrane.
- Check the Probe-frequency is suitable for the probable minimum thickness of the material being measured. Probe frequencies which are too low cause doubling and tripling of the actual thickness.

10. The 5 Point Check

The most frequent reasons found to cause difficulty getting readings are:

1. Is the Probe-membrane fitted correctly?

- Check that there is a thin layer of oil between the membrane and Probe-face, and with no air-bubbles trapped. See [Changing the Membrane](#) on Page 20.

2. Is the Probe-lead OK?

- Check the probe lead is in good condition, look for damage where the lead exits the probe and nosecone. See [Connecting the Probe](#) on Page 10

3. Is there adequate couplant applied to the material being measured, and is the surface properly prepared?

- Check there is plenty of couplant gel applied and there are no air-gaps between the Probe and the material when measuring in air. See [Taking a Thickness Measurement](#) on Page 16.

4. Is the material measurable at all?

- Are the front and back faces of the material parallel?
- Is the material too heavily corroded?
- Is the material too thin for the Probe being used? (See page **Error! Bookmark not defined.**)

It is often worth confirming that the Gauge is operating OK using a test sample, and also to confirm that the material can actually be measured by ultrasonic multiple-echo thickness measurement.

11. Care and Servicing

Cleaning the Gauge

- ✓ A mild detergent may be necessary to remove grease from the O-ring grooves.
- ✗ Do not use solvents to clean the Gauge.
- ✗ Do not use any abrasive cleaner, especially on the display window.

O-Ring Seals

- ✓ Periodically check the condition of the O-rings and always replace them if they appear old or damaged (see page 13).
- ✓ To avoid the risk of a leak : prevent accidental re-use of old O-rings by destroying them after removal.

Probe Membranes

- ✓ Regularly inspect the probe membrane and replace if worn to ensure optimum measuring performance (see page 20).

Batteries

- ✓ Always remove the battery pack if the Gauge will not be used for more than a few days.
- ✓ Only fit 1.5 V Alkaline or 1.2 V rechargeable AA batteries in the battery pack.

Environmental

- ✗ Do not subject the Gauge to temperatures greater than 60°C (140°F).
- ✗ Do not store the Gauge and its kit for long periods in conditions of high humidity.

Repairs

- ✗ There are no user serviceable parts inside the Gauge. Therefore all repair work should be carried out by Cygnus Instruments or by an Authorised Cygnus Service dealer.

Returning the Gauge for Servicing

A full Manufacturer's Factory Service is available from Cygnus Instruments.



The Complete Kit should always be returned for Service or Repair, including all Probes and Leads.

Cygnus Gauges are renowned for their reliability, very often problems with getting measurements are simply due to the way the Gauge is being used. See [Troubleshooting](#) on Page 31.

However, if you do need to return your Gauge for Repair please let us know the details of the problem, to help us guarantee the best possible service:

- Is the problem of an Intermittent Nature?
- Is there a problem turning the Gauge On?
Or a problem with the Gauge turning itself Off?
- Does the Gauge consistently give Incorrect or Unsteady Readings?
- Is it not possible to Calibrate the Gauge?

12. Information

Technical Specifications

General Attributes										
Size	238 mm long x 85 mm diameter (9.4 in x 3.4 in) <i>Including battery pack and probe head.</i>									
Weight	880 g (31 oz) Including Batteries									
Power Supply	Battery Pack with 3 x AA disposable or rechargeable cells. (3 x AA Cells, 4.5 v DC)									
Probe Sockets	Direct cable connection from probe-head to probe-element.									
Battery Operation Time	Approximately 16 hrs with 1500 mA/hr Alkaline batteries.									
Battery Voltage Range	Min 3.0 V dc, Max 4.5 V dc									
Operating Temperature Range	-10°C to +50°C (14°F to 122°F)									
Storage Temperature Range	-10°C to +60°C (14°F to 140°F)									
Low Battery Indication	"Batt" flashed on Display.									
PRF	602 Hz									
Monitor Outputs	N/A									
Through Coating Measurements.	Coatings up to 3 mm thick as standard. Coatings up to 20 mm thick in Deep Coating² mode.									
Materials	Sound Velocity from 2000 m/s to 7000 m/s [0.0800 in/uS to 0.2780 in/uS]									
Measurement Range	Measurement Ranges in Steel: <table border="0" style="width: 100%;"> <tr> <td style="width: 30%;">2¼ MHz probe</td> <td style="width: 30%;">3 mm to 250 mm [0.120 in. to 10.00 in.]</td> <td style="width: 40%;"></td> </tr> <tr> <td>3½ MHz probe</td> <td>2 mm to 150 mm [0.080 in. to 6.000 in.]</td> <td></td> </tr> <tr> <td>5 MHz probe</td> <td>1 mm to 50 mm [0.040 in. to 2.000 in.]</td> <td></td> </tr> </table>	2¼ MHz probe	3 mm to 250 mm [0.120 in. to 10.00 in.]		3½ MHz probe	2 mm to 150 mm [0.080 in. to 6.000 in.]		5 MHz probe	1 mm to 50 mm [0.040 in. to 2.000 in.]	
2¼ MHz probe	3 mm to 250 mm [0.120 in. to 10.00 in.]									
3½ MHz probe	2 mm to 150 mm [0.080 in. to 6.000 in.]									
5 MHz probe	1 mm to 50 mm [0.040 in. to 2.000 in.]									
Accuracy	±0.05 mm (±0.002") - in Multiple-Echo measurement mode, when calibrated and measuring the same material as calibrated on. ±0.1 mm (±0.004") or 0.1% of thickness measurement whichever is the greatest - in Single-Echo & Echo-Echo measurement modes, when calibrated and measuring the same material as calibrated on.									
Resolution	0.05 mm (0.002") or 0.1 mm (0.005") Selectable.									
Display										
Type of Display	4 x 7 Segment LED, Red.									
Display Size	8 mm High.									
Transmitter										
Shape of Pulse	Square									

² To use **Deep Coat** mode consult Cygnus Instruments Ltd.

Pulse Energy : Voltage (peak-to-peak)	30 V p-p
Pulse Energy : Rise Time	25 ns (max)
Pulse Energy : Pulse Duration	110 ns / 135 ns / 230 ns (5 MHz, 3.5 MHz, 2.25 MHz)
Receiver	
Gain Control	Automatic Gain Control up to pre-set Maximum Gain value.
Frequency Range	1.5 MHz to 5.0 MHz (-6dB)
Other Information	
Data Output and Storage.	N/A
Calibration setting storage.	Calibration data stored in non-volatile memory.
Calibration Mechanisms.	N/A (Multiple Echo Gauge)
Display & Recall Facilities.	N/A
Display Response Time.	500 ms
Printer Output.	N/A
Environmental Rating.	IP65 (Dust tight and shower proof) IP67 (Temporary Immersion in water up to 1 meter depth for a maximum of 30 minutes). IP Rating to BS EN 60529:1992
Compliance.	CE, UKCA, RoHS
Designed for	BS EN 15317.

Table of Sound Velocities

Velocities will vary according to the precise grade and processing conditions of the material being measured.



This table is included as a guide only.
Wherever possible, the Gauge should always be calibrated on the material under test.



These Velocities are given in good faith and are believed to be accurate within the limits described above.
No liability is accepted for errors.

Velocities given are the compressional wave velocity c_l .

Material	Velocity of Sound (V)		Conversion Factor (f)
	m/s	in/us	
Aluminium (alloyed)	6380	0.2512	1.078
Aluminium (2014)	6320	0.2488	1.068
Aluminium (2024 T4)	6370	0.2508	1.076
Aluminium (2117 T4)	6500	0.2559	1.098
Brass (CuZn40)	4400	0.1732	0.743
Brass (Naval)	4330	0.1705	0.731
Brass (CuZn30)	4700	0.1850	0.794
Copper	4700 - 5000	0.1850 - 0.1969	0.794 - 0.845
Grey Cast Iron	4600	0.1811	0.777
Inconel	5700	0.2244	0.963
Lead	2150	0.0846	0.363
Monel	5400	0.2126	0.912
Nickel	5630	0.2217	0.951
Phosphor Bronze	3530	0.1390	0.596
Mild Steel	5920	0.2331	1.000
Tool Steel	5870	0.2311	0.992
Stainless Steel 302	5660	0.2228	0.956
Stainless Steel 347	5790	0.2279	0.978
Tin	3320	0.1307	0.561
Titanium	6100 - 6230	0.2402 - 0.2453	1.030 - 1.052

Tungsten Carbide	6660	0.2622	1.125
Epoxy Resin	2500	0.0986	0.422
Acrylic	2730	0.1076	0.461
Nylon (Polyamide)	2620	0.1032	0.443

Reading Conversions

If only a few measurements are to be taken on a material other than Steel, it may be easier to leave the calibration set for Steel and merely convert the readings by multiplying by the **Conversion Factor** for the material being measured.

This method avoids unnecessary recalibration.

Example.

The Gauge is calibrated for Steel [5920 m/s], but the reading is being taken on Copper [4700 m/s] :

$$\begin{aligned}
 T &= t \times V_{\text{COPPER}} / V_{\text{STEEL}} \\
 &= t \times 4700 / 5920 \\
 &= \underline{t \times 0.794}
 \end{aligned}$$

thus : **T = t x f** [where: f = $V_{\text{COPPER}} / V_{\text{STEEL}}$]

where : **T = true thickness of Copper being measured**
t = actual reading obtained
f = Conversion Factor (from table)
 V_{COPPER} = Sound Velocity in Copper : 4700 m/s
 V_{STEEL} = Sound Velocity in Steel : 5920 m/s

The **Conversion Factor f**: is given for various materials in the Table of Sound Velocities

13. Spare Parts List.

Item	Order Code
O-Ring Set 'A', 'D' & 'C', 4 x Pack 10	001-3711
Polyurethane Membranes (6mm), Pack 20	001-3702
Polyurethane Membranes (13mm), Pack 20	001-3701
Polyurethane Membranes (19mm), Pack 20	001-3700
Membrane Couplant	001-3706
Spare HD Battery Pack	001-3722
Tommy Bar	001-2620

14. Recycling and Disposal (EC Countries)

The WEEE Directive (Waste Electrical and Electronic Equipment 2002/96.EC) has been put into place to ensure that products are recycled using best available treatment, recovery and recycling techniques to ensure human health and high environmental protection.

The Gauge has been designed and manufactured with high quality materials and components which can be recycled and reused. It may contain hazardous substances that could impact health and the environment. In order to avoid the dissemination of those substances in our environment and to diminish the pressure on natural resources we encourage you to dispose of this product correctly.



DO NOT dispose of this product with general household waste.

DO dispose of the complete product including cables, plugs and accessories in the designed WEEE collection facilities.

This product may also be returned to the agent or manufacturer who supplied it for safe end-of-life disposal.

15. Index

- Automatic Power Off, 15
- Batteries
 - Charging, 18
 - Life, 17
 - Low Battery Warning, 17
- Battery Pack
 - Fitting, 9
- Calibration, 24
 - Conversion Factor**, 38
 - Jumper Lead, 23
 - Known Thickness, 24
 - Single Point, 25
 - Velocity of Sound, 26
- Cleaning, 33
- Deep Coating**, 35
- Disposal, 40
- Echo Strength, 16
- Gauge Controls, 14
- Gauge Menu, 22
- Imperial, 27
- IP Rating, 5
 - Environmental Rating, 36
- Metric, 27
- Nosecone
 - Fitting, 10
 - Removing, 10
- O-Rings
 - Checking, 13
 - Replacing, 11
- Pitted surface, 30
- Power button, 15
- Probes
 - Frequency, 29
 - Knurled Ring, 20
 - Locking Ring Key, 20
 - Membrane Couplant, 20
 - Polyurethane Membrane Membrane, 19
 - Selection, 19
 - Specifications, 21
- Problems, 34
- Pulse-echo, 7
- Recycling, 40
- Repair, 34
- Resolution, 28
- Rough surfaces, 30
- Service, 34
- Sound Velocities, 37
- Specifications, 36
- Test block, 24
- Thickness Measurement, 16
- Tommy Bar, 10
- Triple Echo Verification, 7
- Troubleshooting, 31
- Units, 27
- Unrelated echoes, 31
- WEEE Directive, 40